

UNIVERSITY OF GEORGIA
LABORATORY OF ARCHAEOLOGY SERIES
REPORT NO. 4

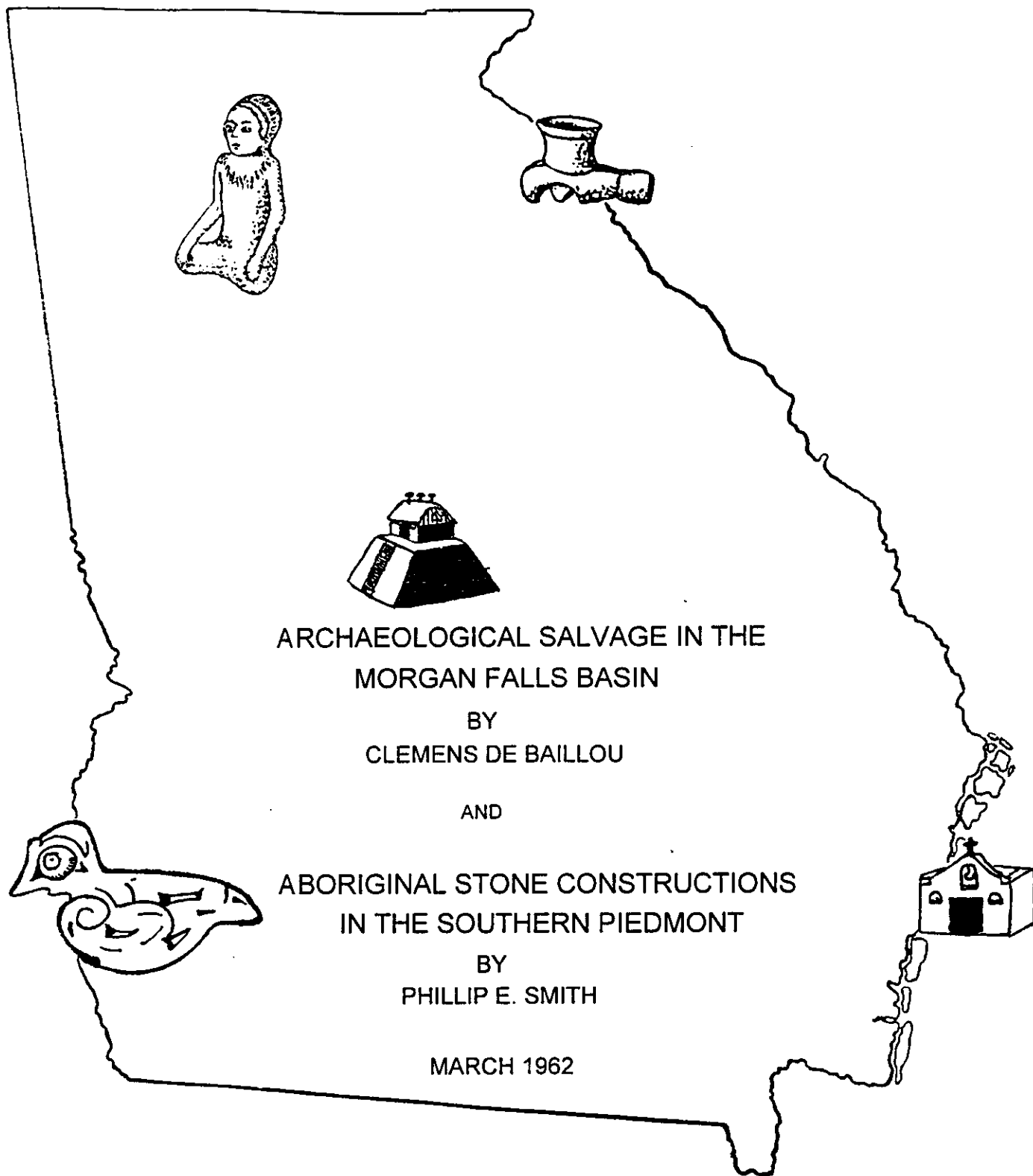

ARCHAEOLOGICAL SALVAGE IN THE
MORGAN FALLS BASIN

BY
CLEMENS DE BAILLOU

AND

ABORIGINAL STONE CONSTRUCTIONS
IN THE SOUTHERN PIEDMONT

BY
PHILLIP E. SMITH

MARCH 1962

PREFACE

This Report no. 4, issued from the Laboratory of Archeology, University of Georgia, continues a program of publication of the results of archaeological survey in Georgia. It fills a special need in making more immediately available notes, materials, and analyses of individual sites and units which do not require a more extensive and expensive medium as is necessary with longer papers or monographs. Some of this site data is currently needed by other investigators in river basin archaeology and the Laboratory reports can get these out sooner than would be possible under other arrangements.

Final river basin reports and other reports on major sites will normally appear as part of the University of Georgia Anthropology Series, published by the University of Georgia Press.

Editorial Committee
for the
Laboratory of Archeology Reports

A. R. Kelly, Editor
John E. Talmadge and John W. Bonner, Jr.
Associate Editors

PART I

ARCHEOLOGICAL SALVAGE
IN THE
MORGAN FALLS BASIN

By
Clemens de Baillou

C O N T E N T S

Foreword	Page 2
Morgan Falls Report.	Page 3-18
Maps	Page 18-21
Illustrations.	Page 21-27

FOREWORD

The survey of the Morgan Falls Development of the Georgia Power Company, carried out by the Laboratory of Archeology of the University of Georgia, is the second salvage operation carried out between the Georgia Power Company and the University. The small reservoir behind the dam extended only a few miles upstream and the amount of history that would be threatened by the undertaking appeared small, yet the accomplishments of the actual survey, modest as they are, represent significant contributions to the total prehistory of the Chattahoochee river basin. Other more extensive segments of Chattahoochee prehistory are represented in the Oliver Basin archeological survey, undertaken for the Georgia Power Company at their Goat Island Dam at Columbus, Georgia; and the surveys now under way by the University of Georgia and the Smithsonian Institution along the lower and middle portions of the Chattahoochee, in connection with the Walter F. George and Columbus dams, under construction by the U. S. Corps of Engineers.

The Morgan Falls Development project in archeology has given fresh evidences of just how rich Georgia's prehistory is, in terms of sites and materials. It proves that almost any five mile square area, located along any segment of a major drainage, will yield important sites of Indian occupation. No doubt exists that other sites and remains were covered over in the river bottoms by twenty feet or more of accumulated silts in the last fifty years. Even so, the rock shelter excavations in this small reservoir, nested a bit higher on the bluffs, have revealed multiple occupations by small groups of prehistoric folk who camped there during various intervals. Something of the life adaptation, the ecological shifts, of prehistoric settlements of the long thread of the Chattahoochee, stretching from north to south Georgia is provided by these excavations in the Morgan Falls Development. A few additional pages of prehistory have been added to the story unfolded in prior archeological surveys in the Allatoona basin to the north, in the Oliver Basin and Walter F. George Basin to the south.

The true history of Georgia, embracing all human experience in this land, goes back eight to ten thousand years before Oglethorpe's initial settlement. The Georgia Power Company has collaborated with the archeologists of the University of Georgia to make possible a more detailed and colorful depth picture of the first Georgians. Every student who reads his texts, and the visitors to our museums, will be grateful for these increments to our knowledge.

A. R. Kelly, Archeologist
Laboratory of Archeology
The University of Georgia

MORGAN FALLS REPORT

Archeological Salvage in the Morgan Falls Basin

In the early spring of 1959 the University of Georgia was approached by the Georgia Power Company which, advised by the National Park Service, got in touch with Dr. A. R. Kelly, Professor of Anthropology, who supervises most of the river basin research and salvage program in Georgia. What they requested was an archeological investigation of the Morgan Falls Basin. A preliminary report was urgently needed by the Georgia Power Company in order to get the permission of the Federal Power Commission to increase the height of the already existing dam by six feet and to raise the water level in the basin accordingly. Dr. Kelly kindly assigned us to do this work.

In March, we began the investigation of the reservoir which is located on the upper Chattahoochee River. It extends from the Northern outskirts of Atlanta, outside Sandy Springs, to the town of Roswell, Georgia--approximately five miles of a narrow river valley with only three major side branches. The geological formation could be briefly defined as weathered micaceous and garnetiferous schist. The slopes of the bordering hills are steep; some form sheer cliffs dropping into the river. Shoals and rapids stretched for three miles above the dam before it was erected. Also in the upper part of the reservoir which was not yet filled, some small shoals interrupted the quiet flow of the river.

In spite of the fact that the area is densely populated and practically a suburb of Atlanta, with a commuting population and many very elaborate modern country homes, the reservoir area itself has remained wild, rugged and swampy, and only partially accessible by automobile or truck. There is no doubt that the swamp spread further since the construction of the dam. The dam was constructed between 1900 and 1903 on the end of the shoals. It was fifty feet high.

Since then, the condition of the terrain has greatly changed. After the construction of the dam, the river began to deposit a large amount of silt. New islands were formed and old islands were covered. Driftwood had settled in side branches and was finally covered with silt. Also in the course of the construction of the dam some quarries were developed to supply the necessary stone for construction. Because of all of these influences growth of vegetation, particularly the more abundant growth of trees, changed the picture of this basin.

A brief report of the preliminary investigation in the form of a letter was submitted to Dr. Kelly and passed on to the National Park Service. In this we stated primarily the following

facts:

- (1) The average thickness of the silt cover acquired over the last fifty years amounts to about six feet which, close to the dam, rises to nearly fifty feet and being, further from the reservoir, only one or two feet thick.
- (2) Counts made of the rings in the recently cut trees along the banks and on the islands indicate that the maximum age of these trees is 47 to 50 years. Therefore, it took the river about five years after the dam was constructed to accumulate enough material to support this growth.
- (3) The most striking number of rock shelters-- slightly overhanging, often fairly deep, cliffs--were situated on Indian sites in the inner basin and close to the future waterline. One of these shelters yielded a piece of pottery to our earliest investigation, thereby suggesting habitation.
- (4) Nearby, but not in the immediate area to be flooded, we noticed some stone mounds which were also recommended for further investigation. We consider this as justified because the increase of the reservoir will also carry along an increase of recreational activities and construction of houses.
- (5) We also noticed in this terrain that the well-known High Tower Trail forded the river between some shoals where a new golf course ("Cherokee Golf Court") is now spreading over the hilltops.

The investigation was made difficult by the character of the terrain as well as by the lack of labor. The season was favorable because neither leaves nor rattlesnakes and moccasins were out.

The Georgia Power Company kindly offered us a field office, the use of a boat, and help in every respect; also a contract which was agreed to by Dr. Kelly and approved by the National Park Service.

On May 10, 1959, we began preparations by acquiring a field office which was next to the power plant; and, with great difficulty, we hired the labor. We were handicapped by bad weather.

On Thursday, May 14, we started to investigate some small

rock shelters in the power plant area. These shelters were threatened by activities connected with the enlargement of the plant other than by the rising of the water. Rock Shelter I in Fulton County was located next to the house of Mr. Ford, the plant engineer. It had a platform 20 feet long and 6 to 8 feet deep under an over-hanging rock. After moving the large layer of slabs collapsed from the over-hanging rock, we excavated down to the bedrock without finding any traces of occupation. Our finds were also negative in the similar Rock Shelter No. 2, located nearby. Here the only sign of occupation was one whetstone, a small plate measuring 2 X 1 3/8 inches. We moved on to Rock Shelter No. III, located on Sullivan's Creek on the land of Mr. Williamson. The main part of this shelter is 58 feet wide and 7 feet deep; 5 feet are covered by an overhang which is about 45 feet high. Outside the shelter the rock walls extended 45 and 50 feet to the West and East. We dug a trench over the slope up to the platform and immediately found traces of habitation. But these traces belonged only to the late 19th and early 20th centuries. There were fragments of late porcelain, China, and Italian faience (painted earthenware); parts of a dutch oven, nails, and an empty cartridge of an eight milimeter rifle!

We proceeded to excavate a 20 X 7 foot square down to bedrock under the shelter, but we found no proto-historic or prehistoric material. The area was very disturbed, but these disturbances are explained by the fact that some years ago a summer cottage was standing there of which only a cistern remains. Next we investigated Rock Shelter No. IV not far away, almost on the hilltop. It was small and proved negative.

We then went to the river behind the bamboo grove just above the power plant. Between the river bank and the bill slope, we dug a testpit 15 X 10 feet in order to determine the depth of the accumulation of river sediments. We followed the contour of the old slope, which we found at a depth of three feet, until we struck water at the depth of 3 1/2 feet. There was no sign of early habitation. Our excavation did prove, however, that there was a very heavy deposition of sediments since the river was dammed fifty years ago. At this distance from the dam, the accumulation might have amounted to as much as 20 feet.

On Monday, May 18, we moved to the other side of the river next to the dam in Cobb County. We began working on an enormous rock shelter (Rock Shelter No. V) 150 feet long with an adjoining rock wall extending 50 feet in the direction of the dam. It looked very promising. We soon discovered that this was the site of a quarry which was used in connection with the dam construction. Approximately 13 feet of the rock shelter had been blasted away; therefore, we ended our 35 X 10 foot trench 13 feet away from the rock. At the depth of 42 inches we hit water. Here the sand deposit

must have reached a depth of 50 feet, as it was so close to the 50 foot high dam.

Further North was a small rock shelter which seemed to have been undisturbed by the reservoir construction. Investigation of this shelter, too, proved negative.

On May 19, we moved to Rock Shelter No. VI (9C021). This shelter is in a narrow ravine below the future waterline and is approximately 1500 feet North of the dam. It is West of the river and 400 feet away from its banks. The overhang of the shelter amounts to 8 feet at its widest point. The sheltered part is about 65 square feet. The innermost part is very low while the outer part rises to a height of 9 feet. Because the Western portion is so extremely steep, the habitable sheltered part is reduced to only about 50 square feet. A small brook carrying very clear water flows close by and on its other side the terrain rises very steeply again. The space was so limited that we actually had trouble disposing of our slack dirt. First we removed 4 inches of topsoil in the sheltered part. The top layer proved to be very disturbed; it seems that modern fishermen were still using this shelter. A heavy, felt-like layer of roots had to be removed, making it impossible for us to continue excavating down to the depth of exactly 4 inches. In this process, we found two potsherds and many quartz and flint flakes. At a depth of about 4 to 6 inches, we noticed a burned spot about $1\frac{1}{2}$ feet in diameter which seemed to have been laid out with stones like a hearth. While scraping the area around this feature, we noticed an even wider dark layer belonging to the strata beneath it. Further back in the shelter the humus had accumulated to a depth of 8 to 9 inches. After removing this, we found many stone slabs belonging to the same strata as the hearth. The slabs did not seem to be arranged, and many were in a tilted position. They could have formed a floor which was later disturbed by the roots of the abundant growth of trees.

In the innermost part of the shelter, however, the slabs definitely formed a floor-like cover. This, on the other hand, could have been a play of nature--we should assume that large layers of the schist rock forming the ceiling dropped to the ground. Next we went to the lower layer, to the depth of about one foot. The stratigraphy now began to show up more clearly. The uppermost layer was just humus; below the humus down to 8 inches we found some stones and slabs along with some pottery and fragments of stone artifacts. Dirt must have been washed in from the West where the slope of the shelter was steep. Below the depth of 7 inches, we

were not disturbed by many roots. On the 8 to 10 inch level two more hearths appeared. One was just in front of the shelter toward the East; there was such a rich accumulation of flakes associated with it, it could have been connected with a workshop. Taking out the next section toward the West, we found in the upper layer only new charcoal, beer bottles, and other disturbances from recent use.

We worked into the shelter. In the lower layer, going down 12 inches, we found early quartz artifacts. Here, too, there were underlying stones which formed no exact pattern. Beneath the slabs spread black or brownish sandy midden full of ash and dirt changing to yellow on some spots. Next to a stone slab we found some plain pottery and two tetrapod legs; there was also an accumulation of crushed quartz. The deeper we went, the more ash was contained in the midden until finally the whole place seemed to be one large hearth. In the innermost parts of the shelter there was much fine yellow clay which had seeped through the cracks of the rocks. This lower layer in which the stone slabs were embedded was thicker here than on either the outside or West side of the shelter. It was 12 inches thick. Below this layer there was no more pottery. At the depth of two feet we were still finding some stone flakes, but we were unable to go further because of ground water which penetrated from the brook. Nor could we go further toward the brook because of our dirt pile of which we could not dispose. We then dug a test-pit on the extreme Eastern corner of the site, but since the ground is very low, we hit water immediately.

In conclusion, we can say that the shelter must have been repeatedly occupied from the archaic period on to recent times. The occupations were always temporary--perhaps they were seasonal. The stone floor of the shelter was probably the result of a collapsed layer of ceiling, but it was doubtlessly used at some time as a floor. The tetrapod fragments found between the stones suggest that the slab layer is approximately 2000 years old.

Description of Material Found in Rock Shelter No. VI Pottery:

1. Plain sand tempered with smooth surface.
2. Plain sand tempered with burnished surface.
3. Plain, coarse sand tempered, containing garnets (indicating local production); straight rim; pronounced interior tooling.
4. Cartersville Check Stamped with curved rim; pot circumference at rim approximately $11\frac{1}{2}$ inches.
5. Simple Stamp (Mossy Oak); red, hard, fine paste.
6. Brushed or combed.

7. One folded Lamar rim sherd with square indentations.
8. Part of tetrapod Deptford bowl; undecorated; coarse, straight rim; 4 inches in diameter and 1-3/4 inches high; resembles to some extent the bowl from Corra Harris Cave now at the Columbus Museum.

Artifacts:

1. Quartz projectiles or blades; Archaic and Old Quartz . . .	12
2. Quartz Flakes	120
3. Blade Flints (one projectile; 1 knife)	3
4. Flint Flakes (blue, yellow, black)	22
5. Hammerstones	
6. Triangular Schist Plates (questionable; no secondary work)	4
7. Polished Ax Fragment	1
8. Blocks of Mica Schist (from innermost part of rock shelter)	2
9. Other stones of local origin which may have been used . .	20

In the middle of June, we moved to the upper end of the reservoir. On the left bank of the river in Fulton County in a large camp belonging to the Atlanta Baptist Association were three rock shelters which we wanted to excavate. The Association kindly gave us permission to do so, advising us to proceed quickly with our work because a large number of campers was expected very soon. The shelters (Rock Shelters VII and VIII; see map) were above the future waterline, but were so close to the river that they would surely have been damaged by the increase in recreational activities.

Rock Shelter VII (see map) is 35 feet away from the river bank-18 feet of this distance is level, and 17 feet is a slope which rises 6 feet. The depth of the covered part of the shelter is 24 feet. Inside the shelter, to the right, or South side, the ground rises and is covered with heavy rock slabs. We dug a trench on the slope, but the area was badly disturbed, and we quickly hit bed-rock. Excavating the entrance to the shelter, on top of the slope, we found some pottery and crushed quartz. The rocks form the threshold-like ridge at the entrance of the shelter and beyond, inside the shelter, they form a basin as we shall see later. Outside the shelter we found traces of fire in what seemed to be an old disturbed firepit or hearth, but we found no pure charcoal. Inside the shelter we found more pottery and crushed quartz and flint. At a depth of one foot we found the last traces of pottery, but crushed quartz, which must have been brought in, was found to a depth of two feet, often under fallen slabs and between loose rocks. Again, it looked as if the accumulation of rock debris had

set an end to the archaic occupation. All of the stones were embedded in a yellow clay. Unfortunately some of the big stone plates were too heavy to be lifted by hand, a fact which to some extent limited our investigation. Going into the steeply rising Western part of the inner shelter, we found some animal bones and archaic stone tools behind heavy boulders; here there was only a small amount of pottery.

Material Found in Rock Shelter VII

Pottery:

1. Rim sherd, straight with curvilinear complicated stamp (Swift Creek?)	1
2. Plain rim sherd with small curved lip	1
3. Rim sherd, smooth paste, plain, straight, tapered rim, 2/3 inch fold; below the fold an incised double line . . .	1
4. Sherds of Cartersville Check Stamped	6
5. Plain or indeterminate sherds	23

Flint:

1. Corner notched stem projectile with straight base; blue flint; Middle Woodland	1
2. Straight stemmed projectile; red flint; Early Middle Woodland	1
3. Blue Flint worked fragment ^h	1

Quartz:

1. Stemless projectile; archaic	1
2. Concave based projectiles; Middle Woodland	2
3. Fragment of stemmed projectile; Early Woodland	1
4. Blades (fragments)	15
5. Heavy Scrapers; archaic	4
6. Partially worked stones	35
7. Hammerstones	2
8. Crushed stones and flakes	500
9. Fresh water shell fragments	

On June 18, we moved to Rock Shelter VIII (9Co22), a few hundred feet down the river from Rock Shelter VII. It is approximately 8 feet above the river bank in a total distance of 77 feet from the river. Sixty-five feet stretch almost level from the river to the slope dropping one foot deeper. The slope rises 9 feet on a 12 foot stretch (see map). After removing much under-

growth we opened a trench on the slope outside the shelter. Here we found the usual disturbances indicating present day use. The sheltered part of the rock shelter is 23 feet deep and has an entrance 13 feet high. The total width is approximately 40 feet but the width of the useful part is not more than 33 feet. On the upper end of our trench at the entrance to the shelter we found a firepit. It seems that in each of the three shelters we dug, the main hearth was located outside the overhang; this was probably done in order to prevent the smoke filling the shelter. Probably only in rainy weather were fires kindled inside. We could not do much inside the shelter because most of the space was covered with enormous slabs of rock which could not be moved. Only two pieces of pottery of any significance were found. One was a part of a highly curved bowl of fine paste, smoothed, and red painted. The other was a most unusual pothandle. It was round, shaped like a circular loop of which the inner wall was not removed; thus there was a concavity on both sides supported by a very thin wall with a fine perforation in the center. This style seemed to us new as far as this area is concerned. It would not be surprising to find it on a Roman bowl or an amphora. It was obviously not a European import, however, because it seemed to have been attached to a coil, and was formed too crudely to have been made by a professional potter on the wheel.

Material Found in Rock Shelter VIII

Pottery:

1. Round handle (exotic type)	1
2. Rim sherd, curved inward, red painted	1
3. Rim sherd, plain; broad outward curve	1
4. Rim sherd, small check stamp; curved outward	1
5. Mixed sherds, plain or indeterminate	14

Miscellaneous:

1. Stones and pebbles, mostly quartz; (1 blue flint)	40
2. Sheet Mica lump	1
3. Burned deer bone fragments	

A short distance up the river West of Rock Shelter VII, was Rock Shelter IX (9Fu23). This small rock shelter is 100 feet from the river bank and 8 feet above the river. Its opening is 5 feet 9 inches high and 1 foot wide. The inside is filled with rock debris and could not be excavated. After having removed much undergrowth, we dug onlay on the slope and the edge of the entrance. Although the results were meager, we found definite proof of early occupation.

Among crushed quartz we found a rim sherd of Cartersville check stamp along with three more very worn sherds probably belonging to the same pot. Again we had the impression that the three shelters (VII, VIII, and IX) were frequently occupied from Archaic to modern times. Erosion and modern man's activities have deprived us of much evidence. Considering the location which overlooks the widespread shoals of the Chattahoochee, which form an excellent fishing area, we may consider the rock shelters as temporary fishing camps serving not only prehistoric and protohistoric man, but modern-day fishermen as well.

Next we moved to the other side of the river to Rock Shelter X (9Co22). The area was inaccessible for vehicles. It lay in swampy river bottoms which were overgrown with trees and swamp vegetation and were frequently interrupted by side branches of the river. The wooded hill slopes were steep, and mosquitoes were a pest. We found out later that the land belonged to Mr. E. I. Bricker of Atlanta, Georgia, who was kind enough not to object to our activities. Rock Shelter X was located approximately 22 feet above the level of the swamp on a steep, wooded hill slope. The shelter is 16 feet deep and 32 feet wide. The height of its opening at the outermost point is 12 feet. Finding no traces of early habitation in the testpits which we sunk in the steep hill slope, we began investigating the shelter. Inside, in the center of the shelter, was a newly dug trench-like fire pit filled with charred wood and beer cans. On the sides was much dirt which had washed in from outside. We first dug a trench from the outer edge towards the center (see drawing). We found some Etowah II pottery. Our laborers were so much troubled by mosquitoes that they kept a smoky fire burning; this made photography in the already rather dark shelter extremely difficult. Next we removed the dirt on the North East which had washed in. It was impossible to do the same on the South Western side because it was covered by a huge slab of rock which could not be moved by hand. Having removed the water-laid dirt, we extended our excavation to the North East and found in the upper layer some parts of a pot with an unusual incised design which may belong to the Cartersville complex. The rim is lipless, smoothly rounded, tapered, and turned inward. The diameter of the rim is approximately 9 inches while that of the wider middle part seems to be about 11 inches. The paste is fine; the sherds are about 1/8 inch thick, and the surface is smooth. The space two inches below the rim is decorated with two incised lines running almost parallel, waving, and often interrupted. They overlap at the point where they meet. In the same level we also found smoothed over check stamped sherds and some sherds of what is probably Cartersville Complicated Stamped. As we continued further to the North East, we did not find any more traces of habitation although we had removed the last layers of waterlaid dirt. We therefore concentrated entirely on the front part of the shelter,

digging down to one foot where we found a black layer in which rather hearth-like concentrations of charred wood or ash often appeared. Again we got the impression that the inhabitants tried to keep their fires outside the shelter. Because of the immediate drop of the terrain, this could not have been easy to do; they must have had to shift their fires very frequently according to the direction of the wind. In this layer we found many flat stones and a very small amount of pottery, most of which was plain. Towards the East, the layer of dark ash disappeared. In the yellow clay we found some pottery together with much crushed quartz and some flint flakes among which was one blue flint pentagonal projectile point. We finally enlarged the square we were digging in the front part of the shelter to $7\frac{1}{2} \times 7\frac{1}{2}$ feet and to the depth 33 inches. Since the profiles did not show any clear stratigraphy, we had to excavate in arbitrary levels. We found, however, indications of three levels of hearths whose centers shifted. A fourth hearth opened about 18 inches below the present surface, embedded in heavy rocks, loose slabs, and bedrock. This last hearth had a depth of 15 inches; its diameter was about 22 inches at the top and it was very narrow at the bottom. It was shaped like a bowl and lined with loose stones which were later displaced by tree roots and were no longer in a perfect pattern. At the present, two trees are growing in the midden. Outside the hearth we found one quartz skinning knife. Most of the pottery which we found on the upper level was plain and thick. On July 8, we began to take out the inner, or back part of the shelter. The upper layer contained very little pottery but much crushed quartz. This layer was disturbed by a recently dug fire trench. Having removed the top layer, we continued on an arbitrary level of 5 inches to take out what we considered a middle layer. In the innermost part was much rock debris. At a depth of approximately one foot, we struck bedrock. There was not much evidence of habitation except for one perfect old quartz stemless blade which we found on the lowest level at the foot of the back wall of the shelter.

Material Found in Rock Shelter X

Pottery:

Upper Layer, Front Portion of Shelter:

- 1 portion of a Cartersville incised pot
- 16 sherds, plain smooth; possibly belonging to one pot
- 1 incised sherd which resembles simple stamped
- 1 sherd red painted plain
- 7 sherds Etowah II
- 3 plain sherds

Middle Layer, Front Portion of Shelter:

- 1 simple stamped sherd, fine paste
- 1 Cartersville check stamped
- 1 very worn check stamped, heavily tempered with fine black crystalline grit

Lower Layer, Front Portion of Shelter:

- 3 Cartersville complicated stamped sherds, heavy paste
- 5 plain sherds, heavy paste
- 3 plain sherds, medium paste

Stone Artifacts:

Upper Layer:

- 2 quartz blades
- 3 quartz blades
- 1 quartz projectile point
- 1 quartz fragment

Middle Layer:

- 3 quartz scrapers
- 2 quartz scrapers (not photographed)
- 1 quartz stemmed projectile point
- 1 quartz hafted blade
- 1 quartz projectile point (willow-leaf shape)
- 10 worked quartz fragments
- 2 hammerstones
- 1 assymetrical, stemless quartz blade

Lower Layer:

- 3 quartz blades
- 1 square quartz hammerstone from the front portion of shelter.
- 1 blue flint blade
- 1 pentagonal black flint projectile from a depth of 3 feet.

Flakes and Crushed Stones:

Upper Layer:

Approximately 210 pieces of quartz

Middle Layer:

Approximately 750 pieces of quartz

5 pieces of flint

Lower Layer (2 - 3 feet deep):

Approximately 300 pieces of quartz

2 pieces of flint

We had received information that some island on the West river bend in Fulton County had been farmed before the dam was constructed. Since the geographical location seemed to us very promising, we tried once again to find an open site. We dug a test square 15.15 feet and one 10x10 feet. At $4\frac{1}{2}$ feet water began to trickle through the fine sand; at $5\frac{1}{2}$ feet we had to stop because of the water. Again we estimated that the top layer of sediments, accumulated in the last 50 years, amounted to at least six feet here in the middle part of the reservoir.

On July 15, we returned to Sullivan's Creek in Fulton County (on the left bank of the river). We had noticed a large rock shelter on the swampy lower part of the creek at a densely wooded spot inaccessible for any vehicles. All the equipment had to be carried through underbrush and swamp to the site from the last houses of the Morgan Falls power plant. Rock Shelter XI (9Fu25) faces northwest. It once overlooked a bay of the river before the construction of the reservoir which brought about an increase of sedimentation. In consequence of this sedimentation, the Sullivan's Creek swamp was extended into the bay. The rock shelter is 15 feet above the creek level. Its rock wall stretches 50 feet from the South West to the North East and then stretches northward for 17 feet. These 17 feet, as well as 17 feet of the wall to the West, are sheltered (see map). Approximately 250 square feet of this space are suitable for habitation. The overhang is 9 feet wide at its widest point and the opening is 17 feet high. A small tributary of Sullivan's Creek drops over the cliffs on the South Western end of the rock wall. First we dug a trench over the hill slope, but this did not produce any evidence of early habitation. Then we removed a top layer of the partly sheltered platform and found the usual disturbances made by modern people; we also found some plain pot sherds. Having removed the top layer, we excavated an area of 9x15 feet to a depth of one foot. Heavy stones and finally bedrock prevented us from going deeper except for a 5x5 foot square in the center of the excavation which we dug to a depth of two feet. In the 8 inch middle layer some plain pottery was found along with very worn check stamped sherds. All of these pieces seem to belong to one pot of which we managed to restore a portion including a section of the rim. The diameter of the mouth of the pot was about $9\frac{3}{4}$ inches; the walls and the rim are straight. Only the last $\frac{3}{8}$ inch of the rim is tapered and slanting outward; the top is cut straight without decoration. The paste is tempered with very fine mica-bearing sand which speaks for its local production. Much broken quartz was found. Since we found no small stone tools, and since the local schist carried strong veins of quartz, these fragments are no proof of a workshop. We found one large stone hoe measuring 11x7 inches and made from local stone.

MORGAN FALLS: STONE MOUNDS

While working on Rock Shelter VI (9Co21), we were told by Mr. Eavenson, the owner of the site, about there being some stone mounds on his property. We found these stone mounds on the upper part of the hills which overlook the ravine near Rock Shelter VI. During a very humid period when it was impossible to work on the shelter we decided to investigate one of the stone mounds hoping to find a correlation with our shelters.

Stone Mound I (9Co22) was on a South East hill slope West of Rock Shelter VI, on the land of Mr. Eavenson. Before we cleared off the accumulation of humus, the mound measured 10 feet in length (North West-South East). A tree stump was in its center. After removal of the leaves and humus, it measured 16 feet in length. At its widest part, about 5 feet from the North West end, it measured about $6\frac{1}{2}$ feet. In the center it is about 30 inches high. This mound was surrounded by an oval ring which measured about 20 feet across its length and 13 feet across its width; there was a space about two feet wide between the ring and the central stone pile. The circular arrangement of stones is particularly well preserved on the West side. The South West and South portions of the circle are formed by slabs standing upright. On the South East side not much of the circle remained; only enough single stones remained to enable us to follow the outline. On the upper end of the central rock pile was a strikingly large round stone. Two lines of stone branched out from it so that the design is V-shaped--it gives the impression of a head and arms. The "arms" are laid out with smaller stones; the left is $4\frac{1}{2}$ feet long, and the right one is $6\frac{1}{2}$ feet long (and 8 to 10 inches wide). After exposing the entire structure, we took out the South East quarter of the center structure without finding anything at all--neither artifacts nor human remains. We got the impression that if this structure were a burial, the corpse must have been lain on the underlying bedrock and covered by the stone pile. Naturally decomposition would have been rapid, there being enough air for oxidation, along with much humidity and probably many rodents and smaller animals such as ants. In order to be sure that no play of nature was responsible for this formation we consulted Dr. Vernon Hurst, the state geologist for the Department of Minerals and Mining. Dr. Hurst agreed that the formation seemed man-made, but suggested that we investigate the bedrock under the upper part of the structure to see if some fold had occurred and possibly produced a loose pile of stones. We followed Dr. Hurst's suggestion and found the bedrock continuing its uninterrupted course sloping towards the South East. This removed every doubt that this structure was not man-made. We should not ignore the possibility that this structure was designed as an anthropomorphic effigy.

Not far from Stone Mound I, to the North East, across a small creek, we found and exposed Stone Mound II. Before the leaves and

humus were cleared, the mound measured 8 feet from North to South and 8 feet, 6 inches from the East to West. The exposed structure measured 15 feet East-West, and 15 feet 2 inches North-South. Exposed, the center structure appeared almost perfectly circular; it had a diameter of 12 feet and was 30 to 36 inches high. The stream runs West to East in a ravine 25 feet South of the mound. As in the case of Stone Mound I, some upright slabs are in the circle. The Western part of the structure lies on bedrock. South and East beneath the layer of humus was a layer of yellow clay 1 to 2 inches thick below which was a thin dark layer (about $1\frac{1}{2}$ inches thick) of humus with black streaks, probably decomposed tree roots. The bedrock exposed on the North West was running in the same direction as the bedrock exposed on the South West. We dug on the East and South East side to a depth of one foot but found nothing. The bedrock slopes rapidly towards the South West and South and it recurs in an unbroken course in the creek bed.

Next we investigated Stone Mound III which was smaller than the others and had no circle. Nor did it produce any artifacts or structural details.

Notes on Observations of Other Stone Mounds in the Morgan Falls Area

There are many stone structures spread over the entire Morgan Falls area. Most of these are small mounds which show some differences in their structures.

One mound which seems to be well preserved is near Rock Shelter VIII on the land of the Baptist camp about 150 yards down the river from the shelter at an elevation of 6 feet. At its base the stone mound is about 12 feet wide; it is 4 - 5 feet high. It has a very striking superstructure, a pile of stones laid across it like logs with overlapping on their corners. We did not touch it.

We found two other similar structures along with many plain stone mounds on the land of the fishing camp South East of the Morgan Falls powerhouse. These mounds are on a steep wooded hill slope facing East (not towards the river) and overlooking an artificial lake. We did not observe any stone structures on the hilltops.

We found two small stone mounds on the land of Mr. and Mrs. Sewell to the North of the Morgan Falls powerhouse.

The largest group of stone structures we found was on a hill-top in Fulton County a considerable distance (approximately half a mile) from the river, 5000 feet (measured on the map) North of

Roswell bridge. The land belongs to an executive of the Coca-Cola Company, so we were told. Timber was cut there in recent years, and a temporary sawmill was in operation. In spite of heavy underbrush, the site is accessible by truck. On the hilltop we noticed some outlines of loose stone walls forming what could have been a square. To the East and South we counted at least 20 stone mounds.

Considering that we have no reports of any artifacts being found in or near such stone mounds, we hope that close investigation of the mounds might reveal structural details which could lead us to make some classification and perhaps ultimately to arrive at a typological sequence.

UNIVERSITY OF GEORGIA
 ARCHEOLOGICAL SURVEY
 FULTON COUNTY
 ROCK SHELTER VII
 MAR. 22 1960

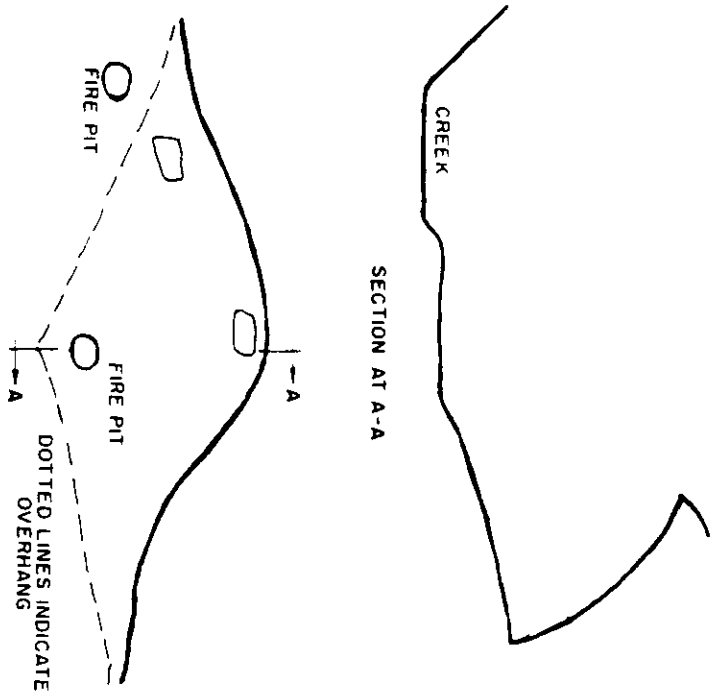
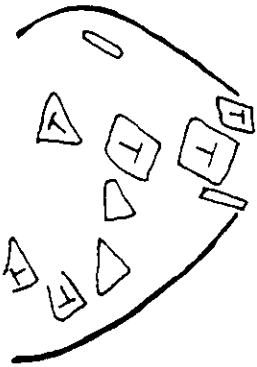

SECTION AT A-A

UNIVERSITY OF GEORGIA
 ARCHEOLOGICAL SURVEY
 FULTON COUNTY
 ROCK SHELTER VIII
 JUNE 16, 1959

LEGEND
 BED ROCK
 SLAB ROCK

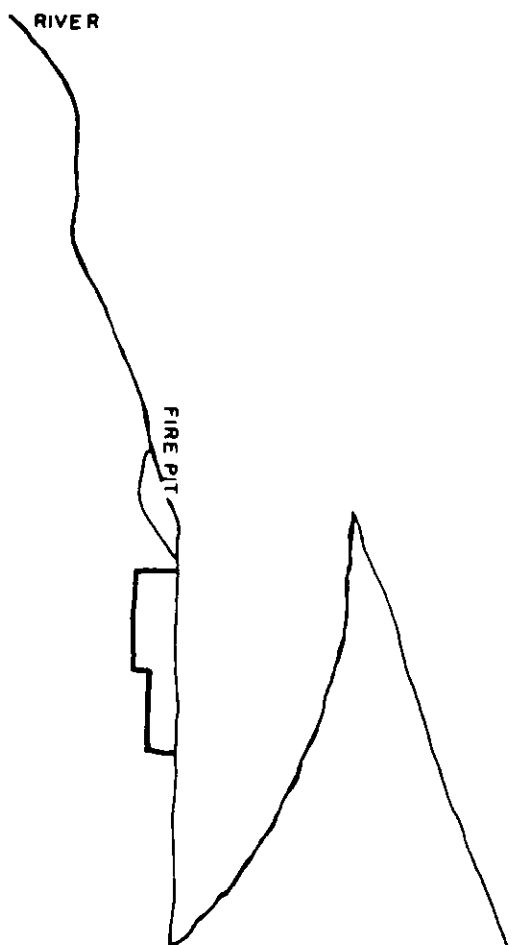
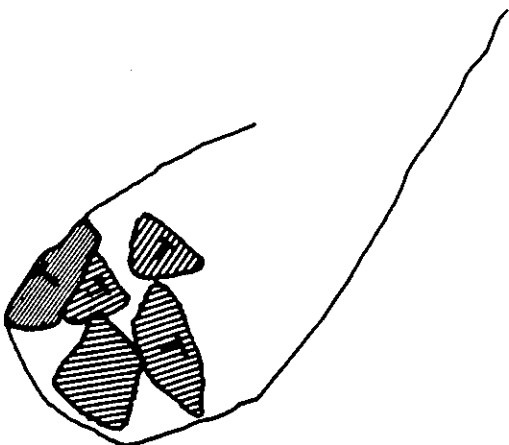

SECTION AT A-A

UNIVERSITY OF GEORGIA
 ARCHEOLOGICAL SURVEY
 FULTON COUNTY
 ROCK SHELTER XIII
 JUNE 18, 1959

LEGEND
 SLAB ROCK
 BED ROCK
 STRIKE DIP

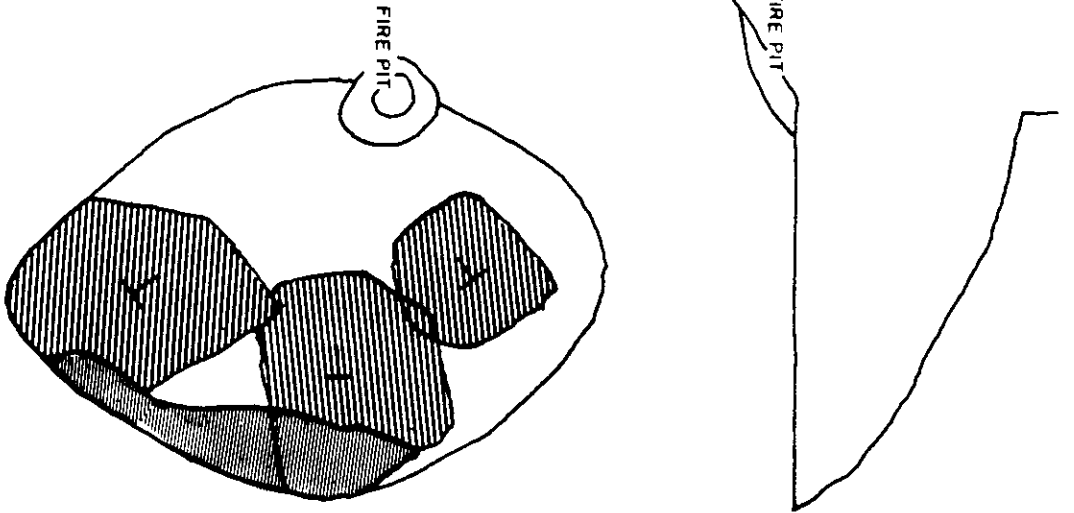

UNIVERSITY OF GEORGIA
 ARCHEOLOGICAL SURVEY
 COBB COUNTY
 ROCK SHELTER IX
 JUNE 22, 1959

LEGEND
 SLAB ROCK
 EX. I
 IN-WASH FILL
 DISTURBED EARTH
 OLD MIDDEN

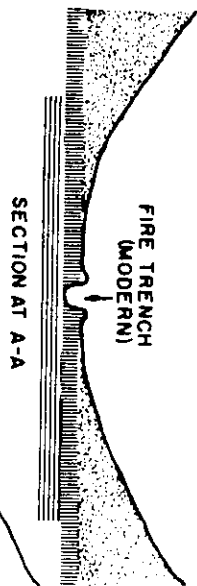
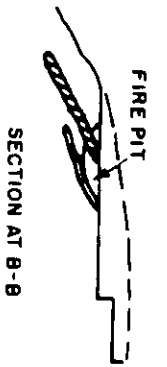
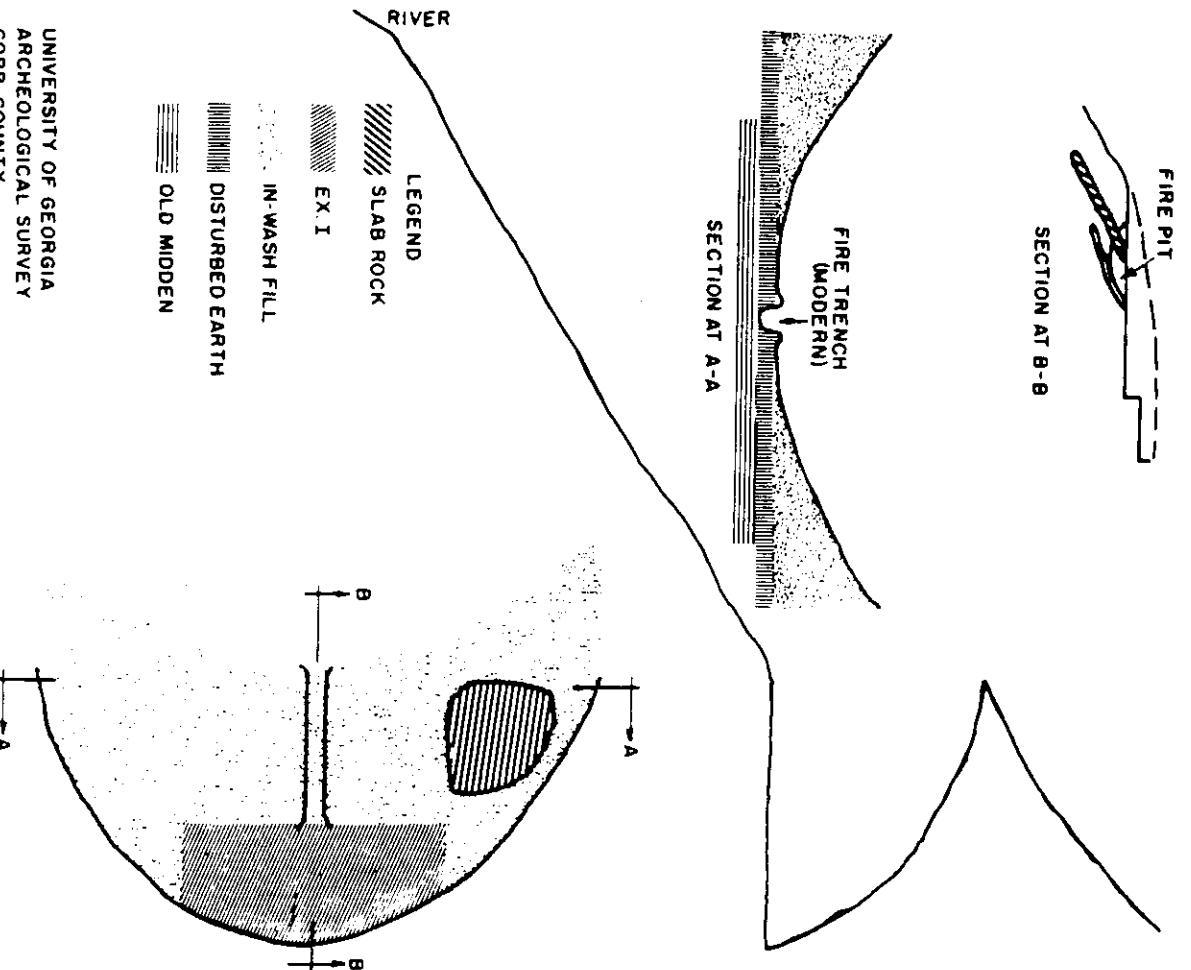

UNIVERSITY OF GEORGIA
 ARCHEOLOGICAL SURVEY
 FULTON COUNTY
 ROCK SHELTER III
 JULY 15, 1959

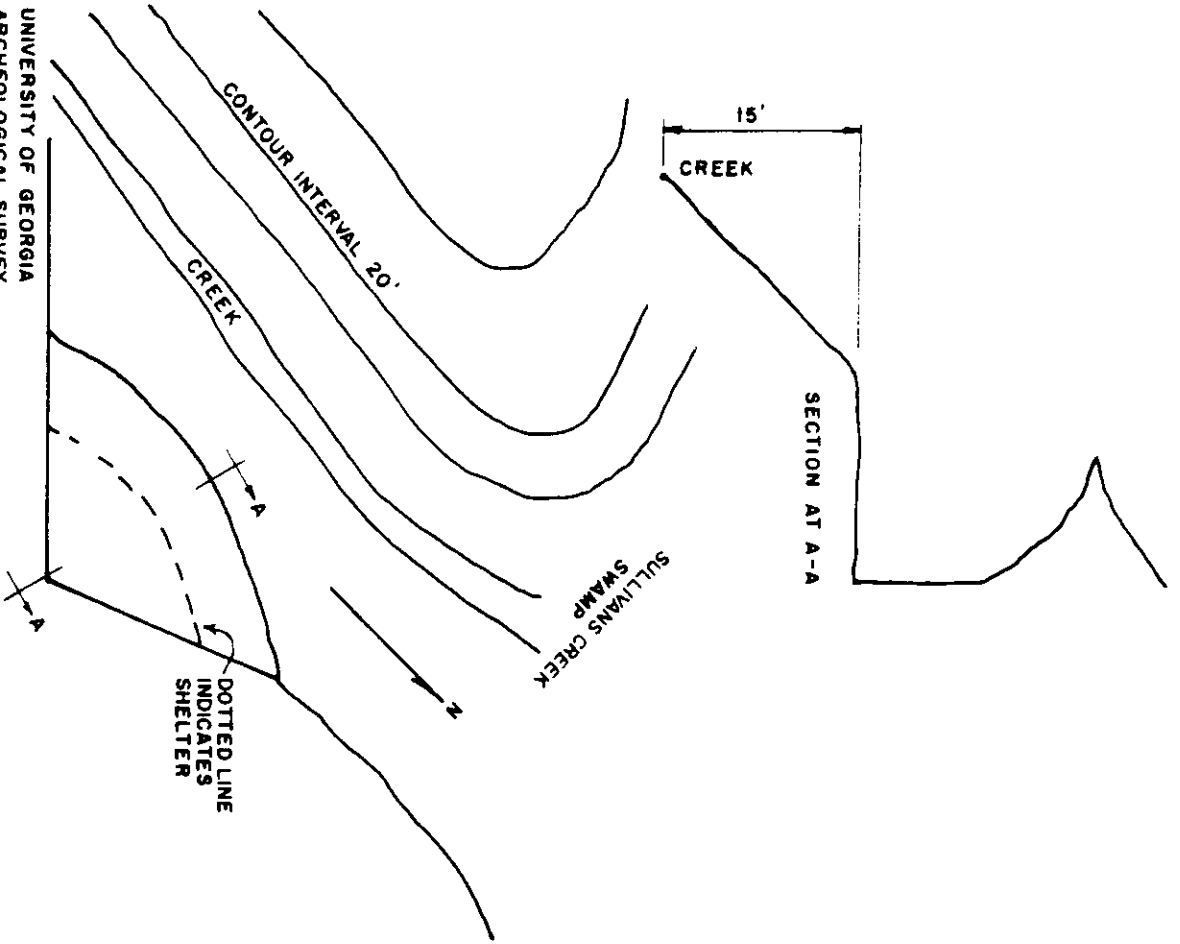
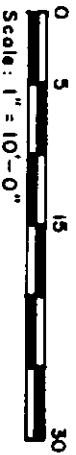

UNIVERSITY OF GEORGIA
 ARCHEOLOGICAL SURVEY
 FULTON COUNTY
 STONE BURIAL
 MAR. 23, 1960

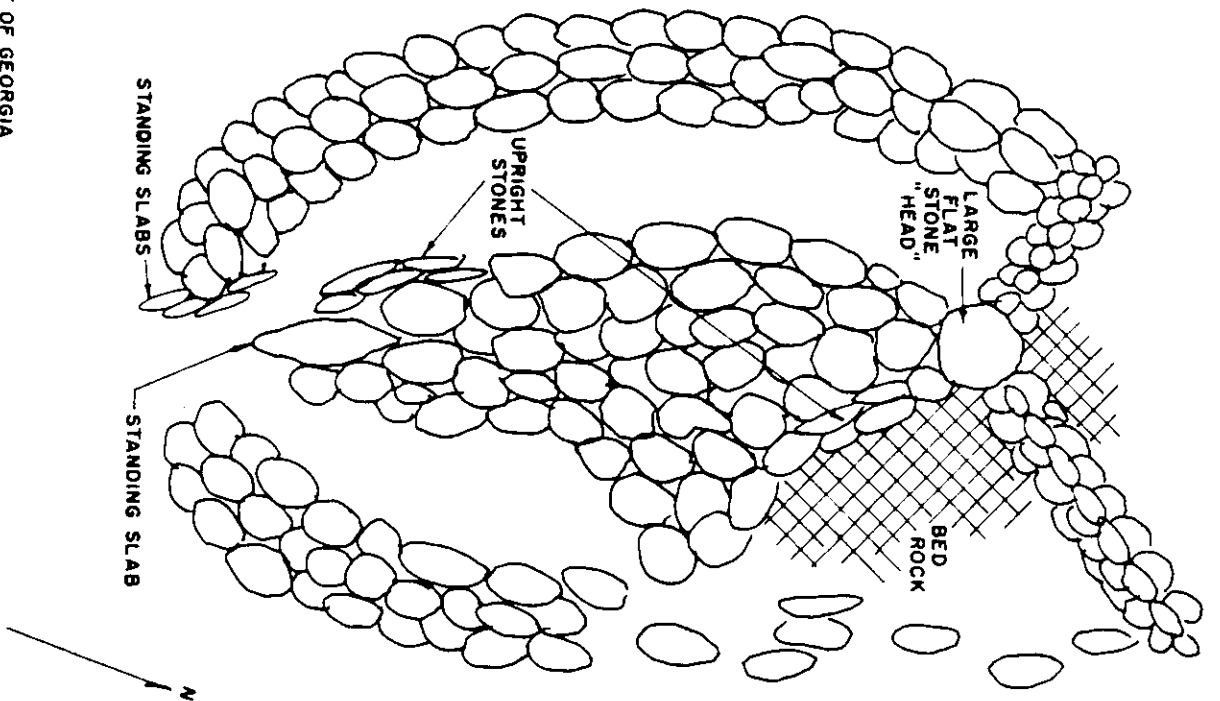
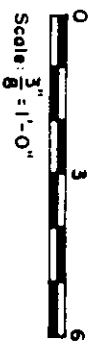

Flint Projectiles (almost actual size)
 Quartz Projectiles & Blades (smallest 1 1/2"; largest 2 1/2")
 Left to Right: (1) Blade 4 1/2"; (2&4)
 Snubnosed Scraper, 1 1/2"; (3) Stemmed
 Projectile, 1-7/8"; (5) Quartz Projectile,
 2"
 Largest 2-1/2"

I ROCKSHELTER 6
 II ROCKSHELTER 7
 III ROCKSHELTER 10
 IV

IV



III



II



I



ROCKSHELTER VIII

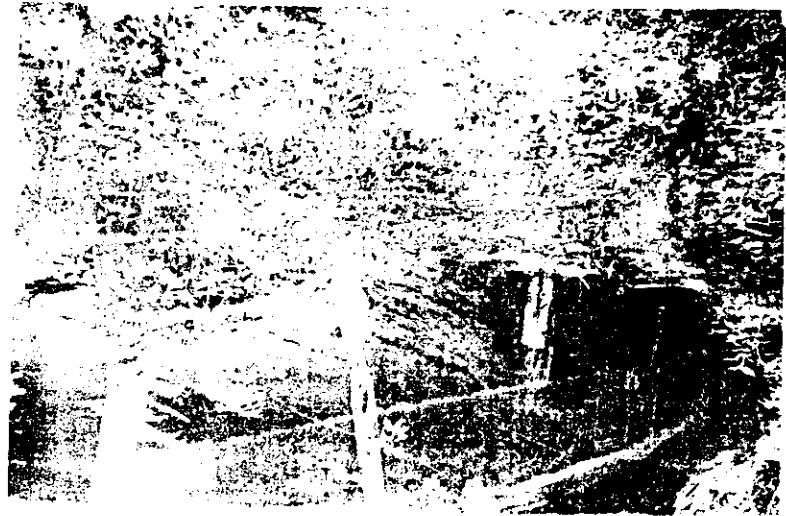

ROCKSHELTER I
LAYER OF STONE SLABS

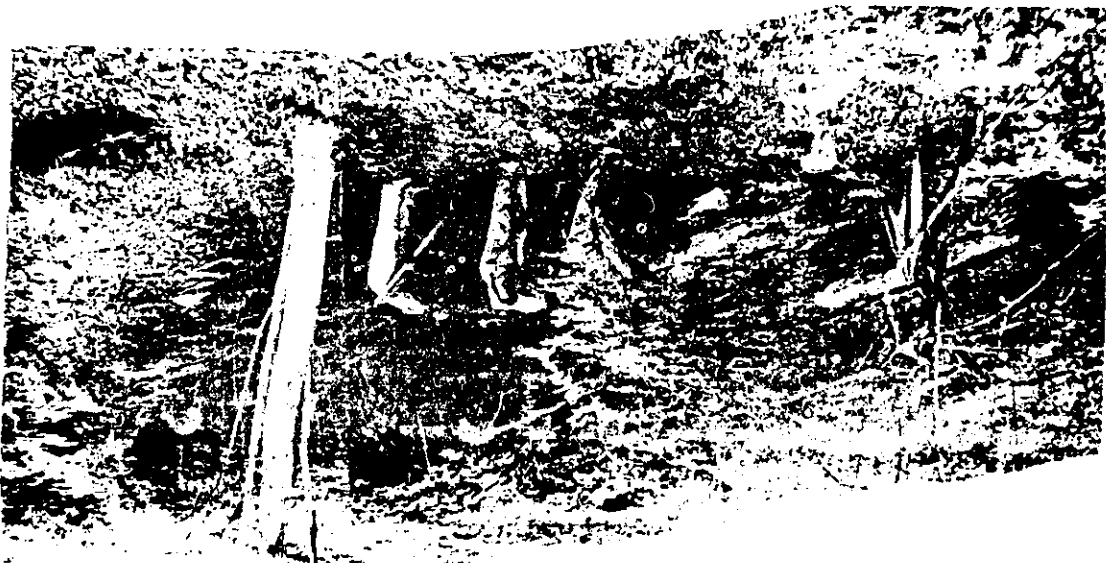



ROCK SHELTER X



STONE MOUND I.



STONE MOUND AT
FISHING LAKE



STONE MOUND AT Mrs.
Sewell's Land

ROCKSHELTER 6. I. Plain Mica & Garnett Tempered
 II. Cartersville Check Stamp (6")
 ROCKSHELTER 10. Simple Stamped
 IV. Cartersville Complicated
 V. Cartersville Check Stamp
 VI. Etowah II
 VII. Incised (unknown type, 6 1/2")

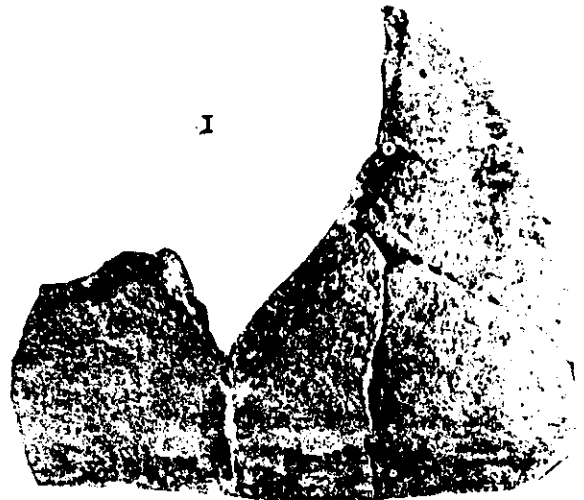
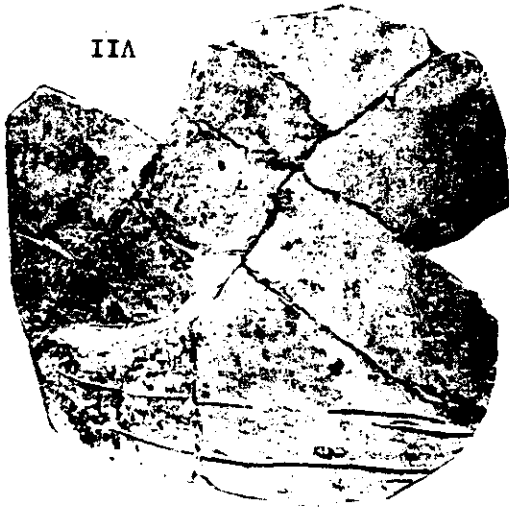

I ROCKSHELTER 8 Pothandle
 II ROCKSHELTER 6 Tetrapod Bowl (actual size)
 III ROCKSHELTER 6 Triangular Plate, 2 1/2"
 IV ROCKSHELTER 7 Quartz Blades & Scrapers
 V ROCKSHELTER 7 Quartz Blades & Projectiles
 1 1/2" to 2 1/2"

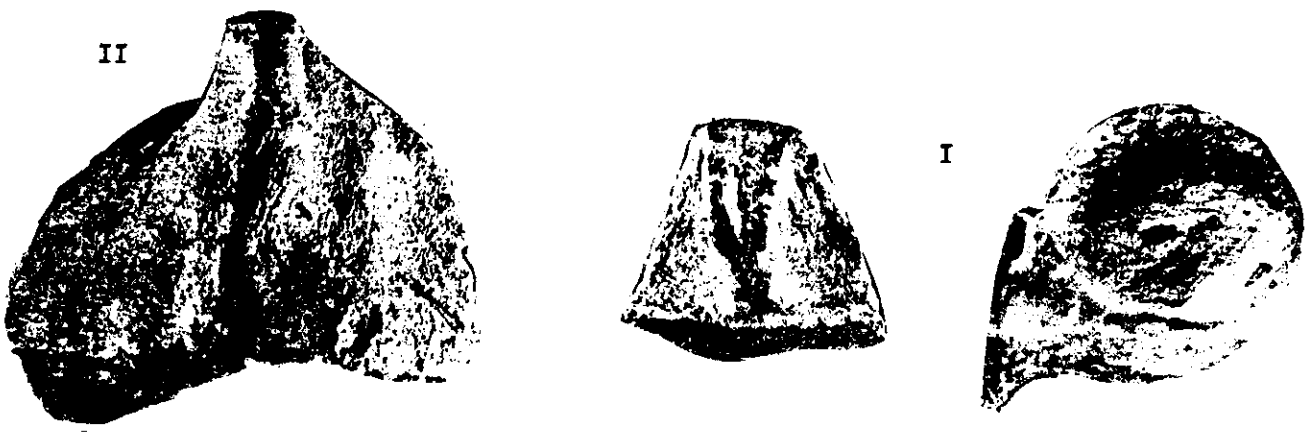

PART II

ABORIGINAL STONE CONSTRUCTIONS IN THE SOUTHERN PIEDMONT

(Report on field work in 1955 and 1956,
submitted to the Department of Archaeology
and Anthropology of the University of Georgia,
October, 1956.)

Philip E. Smith
Peabody Museum
Harvard University
Cambridge, Massachusetts

C O N T E N T S

- I. Introduction

- II. A. Fort Mountain, Georgia
B. Alec Mountain, Georgia
C. Sand Mountain, Georgia
D. Ladd Mountain, Georgia
E. Rocky Face Mountain, Georgia
F. Kensington Wall, Georgia
G. Mount Alto, Georgia
H. Brown's Mount, Georgia
I. Lookout Mountain, Tennessee
J. De Soto Falls, Alabama
K. Madison County, Kentucky
L. Mount Carbon, West Virginia

- III. Summary and Conclusions

- IV. Appendix: Miscellaneous Constructions in
 - A. Georgia
 - B. Kentucky
 - C. Tennessee
 - D. Indiana
 - E. Ohio

- V. Bibliography

I. INTRODUCTION

The archaeological literature of the past century contains a number of casual references to stone walls, stone mounds and stone effigies in the southern Appalachian and Piedmont regions of Georgia, Tennessee and Alabama and of districts as far north as Kentucky and West Virginia. This is particularly true of some of the publications of the late 19th century, and in several cases brief descriptions and tentative conjectures were made if the structures were impressive enough. However, these data seem never to have been treated as part of a possibly related body of phenomena or as the complex which is now suspected to be, although in the last decade or so such Southeastern archaeologists as Kelly, Fairbanks and Waring have felt that the occurrences merited more intensive treatment.

The failure or rather the reluctance to study this problem is perhaps inherent in the nature of the constructions. As a rule they occur on ridges or mountain summits, usually in rather inaccessible localities; they are not promising sites for recovering artifacts or other archaeologically identifiable specimens; and in addition it is usually not easy to determine, by reason of their amorphous forms and configurations, whether they are aboriginal or more recent works.

The purpose of this paper, then, is to provide some sort of trial survey, mainly descriptive, of certain of these stone constructions. Only the stone walls, enclosures and "forts" will be discussed at any length here; it is not practical or convenient to deal with the above-mentioned stone mounds and effigies at this time since the writer has insufficient material and experience relating to them. Some of the data presented here were salvaged from existing archaeological literature, and the sources are given in the attached bibliography. However, the greater part of the evidence is the result of field research and reconnaissance during the 1955 and 1956 field seasons.* This survey, and the present resulting summary of results, are initial in almost every sense of the word and the conclusions reached to date reflect this state of affairs. To put it in a nutshell, the aim of this paper is exploratory, the method is mainly descriptive and the conclusions are highly tentative. Nevertheless it is felt that what is probably a significant clue to the cultural picture of the prehistoric eastern United States has been overlooked, and that the results of work so far should be presented in some kind of synthesized form now rather than held up for the results of further field research which is contemplated for the future. Possibly this paper may focus attention on this facet of southern archaeology and serve as a reservoir of accumulated data for the convenience of other investigators.

II. A. ARCHAEOLOGICAL RECONNESSANCE IN
FORT MOUNTAIN STATE PARK, GEORGIA

* * * * *

*During the 1955 field season the work was sponsored by the Department of State Parks of the State of Georgia, and was carried out for the most part in the Fort Mountain area. In 1956 the work was done under the auspices of the University of Georgia, with some support from the Evans Foundation of Chattanooga, Tennessee. Appreciation is expressed to Dr. A.R. Kelly of the University and to Joseph W. Johnson, Jr., M.D., of Chattanooga, who were the original backers and chief supporters of the project.

UNIVERSITY OF GEORGIA
ARCHEOLOGICAL SURVEY
FORT MOUNTAIN STATE PARK

LEGEND
--- TRAIL
○ PIT IN STONE WALL
● ROCK OUTCROPS
AND BOULDERS

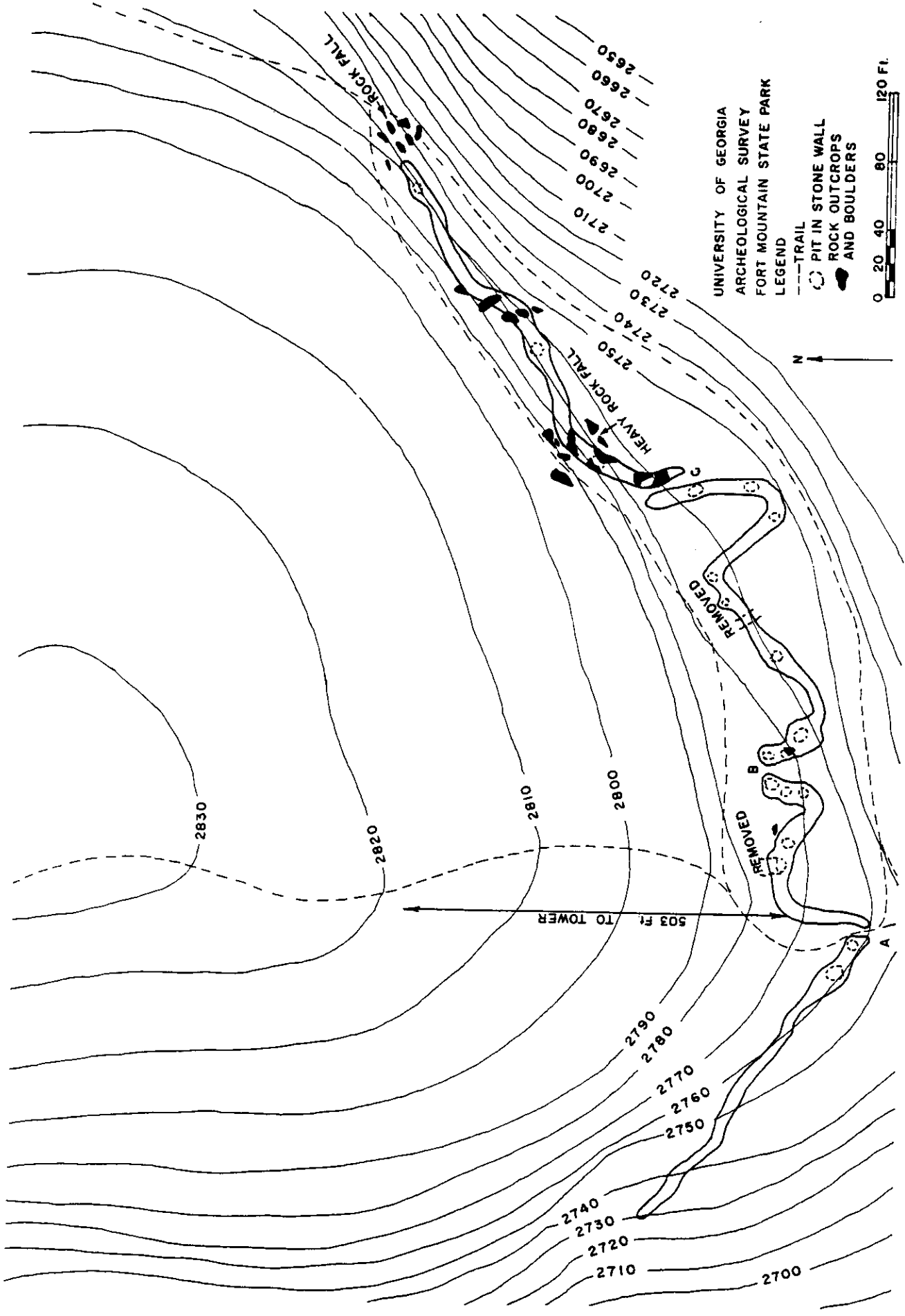

Description of the Wall

The wall is situated near the saddle which separates the summit of Fort Mountain, on the north, from the somewhat lower peaks and ridges to the south. It is approximately 1200 feet north of the picnic area, and some 500 feet south of the memorial tower on the summit.

At present the wall consists of a long, discontinuous line of stones zigzagging across the slope at approximately the 2750-2760 foot contour lines (see the attached map). It is composed of native stone from the surrounding region of the summit.¹ The size of the stones vary from small ones of a few pounds to extremely large boulders of several tons. Although the height of the wall also varies, the average, as measured at a number of places, is between 3 and 4 feet although in several places it attains a height of about 10 feet. There is also a great variation in the width, the maximum measured being 16 feet and the minimum $4\frac{1}{2}$ feet. The wall is not continuous at present but is broken or interrupted in three places so that we are actually dealing with four walls. Through one of the breaks the present trail leading to the tower proceeds, and it is probably a recent effort; the other breaks, one of which is commonly described as the "Gateway", will be discussed in more detail later. For the most part the wall is composed of portable stones deliberately piled, but in several areas, especially on the eastern end, a number of large rock outcrops are incorporated into the construction.

The wall is studded with a number of holes or pits, some of which are rather wide and deep while others are merely shallow depressions. These features are shown on the attached map, and it will be seen that where they occur the wall is somewhat wider and presents a swollen appearance. In all there are 19 of these pits. These too, will be discussed later.

A word should be said concerning the length of the wall itself. This is usually given as 885 feet. It is notoriously difficult to obtain accurate measurement on a structure which meanders and zigzags in this fashion, particularly when the wall is broken in three places; but the writer's calculations place the total length of the wall (including the three gaps) at approximately 928 feet.

For a survey of this nature a plane-table is probably preferable, due to the thick underbrush and forest growth which hamper accurate long-range shooting with transit and tape. However, it was not possible to obtain a plane-table during the season so the survey was accomplished with a transit. The results of the survey are incorporated in the attached map which forms part of this report.

¹According to a communication recently received by the writer, the wall was examined a short time ago by Dr. William Tanner of the Department of Geology of the University of Florida. In his opinion the stones are from the local area around the summit, and the large boulders incorporated into the wall lie as simple floats which have not been moved into unusual positions.

8

It should be remarked, in connection with this map, that in the absence of a bench mark on the summit of Fort Mountain the base of the Observation Tower was used and a line surveyed downhill due south of the tower until it intersected the wall near the trail entrance at a distance of 502'10".

The height contours shown on the attached map are obtained from the U.S. Department of the Interior and the Georgia Department of Natural Resources.

At the end of the survey, two minor excavations were made by removing two sections of the wall down to bedrock. The sections removed are shown on the attached map. One excavation was in a pit, the other in a section of the wall 6 feet long. In the first case the stones of the wall rested on a thin layer of earth covering the bedrock, while in the second the wall was laid directly on the outcrop. A small trench was also dug in the earth which had accumulated along the inner side of the wall, but nothing was recovered. The only result of these excavations was a greatly increased respect for the amount of effort which went into the building of the wall, since it required the continuous work of two men for a full day merely to remove and then replace the stones in the six-foot section which was examined.

Discussion

It is not difficult at first glance to describe this construction as a "fortification" and indeed there are some superficial features which seem to reinforce this belief. The wall gives the impression of being situated just about where a fort should have been placed, if one were required, in relation to the topography -- that is to say, near the relatively narrow saddle which connects the larger mass of the mountain with the summit. Thus the wall would appear to block the passage across the saddle to the higher land, while its ends extend to the rather steep faces of the east and west sides where, presumably, the topography would offer sufficient difficulty to attackers.

But closer examination of the supposedly fortress-like qualities of the wall tends to weaken belief in this function. For one thing, the wall is rather low for a defensive construction, and although very possibly it stood somewhat higher in the past, yet the amount of stone remaining in the immediate vicinity of the wall would preclude an original average height of more than four or five feet. There is no evidence at hand to indicate that it had been made higher by logs or branches, although this is not entirely impossible.

A more serious disqualification of this theory is attained by an examination of the form or design of the wall. The curves and zigzags mentioned previously inevitably bring to mind the bastions and salient flanks familiar from European type fortifications. But it should be strongly emphasized that in nothing but general appearances do these zigzags resemble true fortification techniques. They are not aligned or built with any consistent intention of taking advantage of the contours of the slope; indeed, in some

STONE STRUCTURE ON ALEC MOUNTAIN HABERSHAM CO., GEORGIA

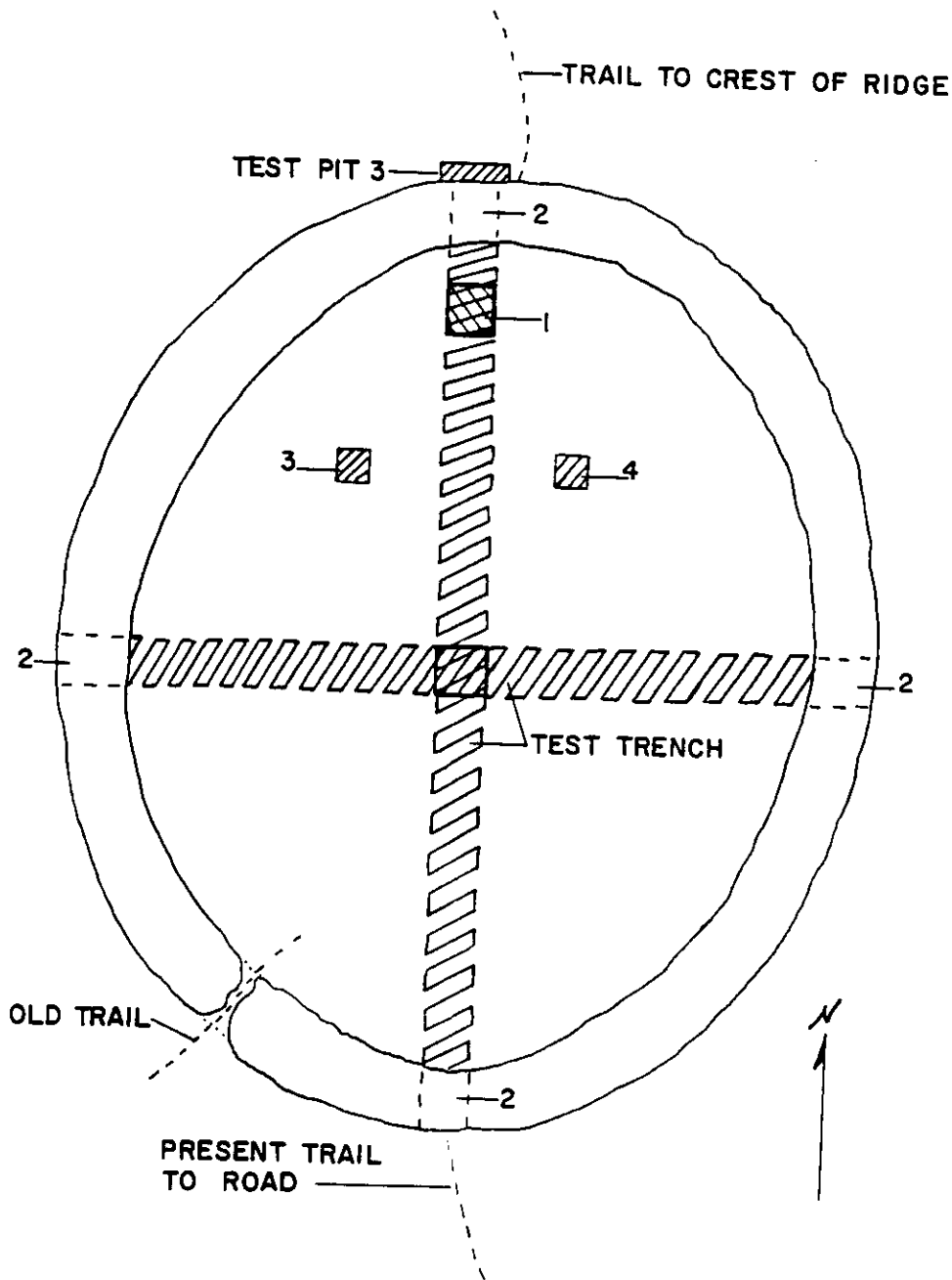

--- LIMIT OF EXCAVATIONS

 EXCAVATIONS AT
2 FOOT DEPTH

 EXCAVATIONS AT
5 FOOT DEPTH

1- STONE RECTANGLE

2- WALL REMOVED

3- TEST PIT 1

4- TEST PIT 2

0 20 40
FEET

cases they actually seem to fail to take advantage of potentially strategic contours. The presence of the largest curve of all, about one-third of the distance from the west end, is a case in point: here, instead of the wall striking directly across, it makes a sharp dip downhill for some fifty feet in such a way that any defenders behind the wall would inevitably be exposed to fire from attackers outside.¹ The same holds true, to a lesser degree, for the other curves and twists; they have no apparent strategic value whatever, and in most cases would be positively detrimental to any defenders.

In one locality the wall is very poorly situated indeed from the point of view of defense. The eastern third of the construction is on somewhat higher ground than the rest and skirts some very large outcrops of rock, including many loose boulders, and a steep cliff. But in one particular part of this region the situation has very doubtful defensive value. In the present condition it is quite feasible to use this heavy rock fall as a protection in approaching the "fort", by climbing up the rocky slope to the very wall, and in this case the defenders would be exposed and the attackers would be covered.

The pits, or "pillboxes", are often quoted as evidence to support the fortress function of the wall, on the assumption that they were used as emplacements for archers or such defenders.² This theory can be disposed of fairly quickly. In the first place, the pits are of extremely variable sizes, some being as much as 13 feet wide while others are not large enough to hold a single individual. Second, these pits are not arranged with any eye to defense; the first 180 feet of the wall, on the west side, lacks any pits, whereas in other sections two or three may be crowded together along 20 or 30 feet of the wall. Third, and most damning of all, there is some very good negative evidence that these pits are very recent constructions. In an archaeological description of the wall on Fort Mountain published in 1893,³ careful attention was paid to the shape, composition and position of the wall and its relationship to the topography, but no mention at all was made of any of the pits or holes which are so noticeable today. There is no reason to doubt the reliability of this description, and although the date of the author's inspection of Fort Mountain is not indicated it presumably was shortly before 1893. In other words, these supposed emplacements for archers are of quite recent manufacture and were probably made by gold-hunters or treasure-seekers. This tends to confirm rumors which are occasionally voiced in Chatsworth and the neighboring countryside. The pits have been shown on the attached map merely because they occur and form

¹It is sometimes held that this unusually long dip existed to protect a well or spring. No trace of such a spring has ever been reliably reported, and an examination by the writer showed no signs of such a water supply inside the loop.

²For example, see W. K. Moorehead's Etowah Papers (New Haven, Yale University Press, 1932), pp. 155-56.

³Shackleton Jr., Robert. Fort Mountain, in the American Antiquarian and Oriental Journal, vol. XV, 1893, pp. 295-304.

such prominent features of the wall, and because they should be thought to have any intrinsic significance.

Finally, one other deterrent to the "fort" theory ought to be mentioned -- the absence of a water supply inside the wall. This should not be advanced too strongly, perhaps, since the absence of a spring or well at the present time does not exclude the possibility of such a source in the past. But it does remain a fact that today, as far as could be ascertained, there is no water supply inside the wall. If the same situation obtained in the past it is perhaps to be doubted that a group of defenders would allow itself to be cornered in such an inhospitable position.

The absence of any sort of archaeological remains inside the wall should not be taken too seriously for either side of the argument. The soil is thin and perishable refuse would quickly be destroyed by exposure rather than preserved by chance burial. While the writer has never seen any weapons, tools or projectile points recovered from the vicinity, these have evidently been found occasionally for Shackleton, in the article quoted above, mentions finding a few arrowheads inside the wall. These may well have been ordinary hunter's equipment. In any event, even if the construction had been a fort, the absence of any evidence of warfare would be no argument to the contrary; this wall, whatever its function, seems to have been a planned and deliberate undertaking involving considerable time and effort, and not a casual or temporary retreat, yet it was not of course inevitable that it should have suffered an attack.

The three "gateways" have been indicated on the attached map by the letters A, B and C. As mentioned before, A (through which the trail to the Tower leads) is probably a recent cut, though no positive proof is available concerning it. The writer is unable to offer any real explanations for B and C.¹ Possibly they are genuine gaps, and the walls never were connected in these areas, although this seems hardly likely in the case of C where the two walls run parallel to each other for a short length. Possibly -- although the writer is inclined to think it unlikely -- some careful excavation in the vicinity of B might be rewarding in this respect.

Summary regarding the Wall

It is easier to say what this wall is not than what it is. Almost all the theories invented to explain its history or origin can be easily disposed of. It obviously did not originate during the War Between the States, as is sometimes suggested, since there is a reference to it in a volume published in 1849, and the Moravian missionaries who were in the neighborhood of Spring Place in the early 19th century allegedly observed.³

¹It may be significant that in the above-mentioned article (Shackleton, 1893), the wall is described as having only one entrance. Unfortunately the position of this entrance is not further identified by the author.

²White, George. Statistics of the State of Georgia, Savannah 1849, p. 442.

³Shackleton, op. cit., p. 298.

There is no evidence, either documentary or archaeological, to support the theory that DeSoto or his expedition were responsible. The party does not seem to have passed through this particular region, nor, in any case, was he having difficulties with the local natives. Certainly with his equipage of horses and pigs, Fort Mountain would be one of the last places DeSoto would visit. In the same way there seems to be nothing which would support the idea that later Spaniards, or any other Europeans, constructed the wall for defensive purposes. If they had, the writer feels that they would have built it in a quite different manner. The doctrine put forth in some quarters¹ that the wall was built by Prince Madoc of Wales in the 12th century is, it must be emphasized, entirely an unsubstantiated hypothesis; in spite of the vociferations of its followers it has no reliable basis in archaeological or historical fact.

The conviction of the writer (and of Dr. Kelly) is that this wall is of aboriginal origin, constructed by the prehistoric Indians of the area. This statement, it must be confessed, is based on no very concrete evidence, and probably should be made with a good deal of caution. Almost no work has been done on this kind of problem in American archaeology - in fact, it appears that the investigation of 1955 were the first to be directed to an intensive study of such phenomena - so such conclusions must be taken for what they are worth until more substantial evidence is forthcoming. It is not likely that we will ever be fortunate enough to discover artifacts or archaeological remains in the walls themselves; as mentioned before, two sections of the Fort Mountain wall were removed in this connection, without success. They hardly seem the places to deposit such articles as would provide clues. There is a suspicion - and it is no more than that yet - that the stone walls which are found in the Southern Appalachians and Piedmont regions of the South may be related in some way to the stone mounds and stone effigies which occur in the same areas. In the mounds and effigies, archaeological remains - skeletal and artifacts have occasionally been recovered, and on the meagre data we have up to the present time it seems possible that these may belong to what are known as the Archaic and Woodland Periods in North American prehistory -- perhaps 4000 to 2000 years ago. But this, it must be repeated, is still only an hypothesis which will require much more testing and research.

It should also be mentioned that the wall on Fort Mountain is not entirely unique in the South, although it is the largest and most impressive found to date. A number of other stone walls have been reported and it is possible that they all belong to a very ancient complex which may have been religious or symbolic connotation. While a few of these walls have been mentioned in archaeological literature before, a number of them have come to light as recently as the summer of 1955 and the writer has had the opportunity to inspect most of them. They bear certain things in common. All are of dry-stone masonry, although the quality varies greatly; most of them

¹For example, Zella Armstrong's Who Discovered America? the Amazing story of Madoc. Lookout Publishing Company. Chattanooga, 1950.

are built on hilltops or ridges, yet without any ostensible defensive purpose; none of them appears to have any historical background as far as white settlement is concerned. For example, there are the long Devil's Half Acre walls in Putnam County, Georgia, which have well-fitted masonry of unworked stone; the wall near Kensington, Georgia, (just south of Chattanooga, Tennessee,) reported by Dr. Joseph Johnson in 1955; the stone "fort" at Manchester, Tennessee; the parallel walls at DeSoto Falls, Alabama; the wall on Ladd Mountain near Cartersville, unfortunately demolished some 20 years ago; the stone wall on Brown's Mount near Macon, also demolished recently but described by A. R. Kelly in 1938.¹ In addition, there are unexplained lines of stone on Mount Alto, near Rome, Georgia, which seem to resemble the same type. Finally, there is a number of such structures reported from West Virginia, Kentucky and Tennessee which the writer has not yet had an opportunity of observing but which appear, from the descriptions, to fall into the same general class.

The widespread distribution of these phenomena leads to the suspicion that a common motif, perhaps ceremonial or symbolic, underlies them. Certainly the outline form of the wall on Fort Mountain, with its twisting and curving, bears some resemblance to earth walls in the form of serpents and other shapes found in the Midwestern states, and one is tempted (with no sound evidence, or course) to suggest that the Southern walls were the counterparts or even the progenitors of the northern ones.

Whatever the ultimate origin of these constructions, the writer is convinced that the deciding clues will not be found by intensive excavation of individual walls, although some of this might profitably be done where feasible. The proper approach must be a distributional and geographical one; that is, to locate as many as possible of these occurrences, to describe them thoroughly, and to see how, if at all, they compare with each other and whether they can be tied in with other more easily identified archaeolgocial features of the regions. In this respect it might not be amiss to draw a parallel with a problem in European archaeology which deals with a somewhat similar set of remains and where the approach suggested above has been profitably applied. This is the so-called "Megalithic problem" dealing with the stone tombs, enclosures, and upright blocks (e.g., Stonehenge in England) which are found all through the Mediterranean, western European and Baltic regions. Careful studies of these in relation to their occurrences, forms and sometimes contents have given very valuable informatio~~n~~ concerning the origin, evolution and spread of these elements and the people who built them, whereas each studied individually would give very little data. Certainly the same approach could be usefully employed on the subject of the stone walls in the South.

¹Kelly, A. R. A Preliminary Report on Archaeological Explorations at Macon, Ga. Bulletin 119, Bureau of American Ethnology, Smithsonian Institution, Washington 1938, p. 25.

Explorations in the Vicinity of Fort Mountain

It was decided before the project started that an effort should be made to investigate the immediate environs of Fort Mountain to check any other stone walls and to look for sites which might possibly have a bearing on the wall on the summit.

According to local accounts, there exists a fissure or cave in a section of Fort Mountain known as the Beehive Cliffs, on the eastern side of the saddle. Apparently this opening can only be reached by rope from the top, but I could find no one who had ever reached it. The way to these cliffs lies along extremely rugged terrain and, according to the Park Superintendent Mr. Winkler, is inaccessible during the summer due to dense undergrowth and snakes. An attempt was made by the writer to examine the area, with the help of a local workman, but unfortunately it was found impossible to reach for the reasons mentioned. In any event there is no evidence that this opening has any archaeological significance, although it might bear investigating when conditions permit.

It has been known for some time that two smaller walls exist on the north side of Fort Mountain, perhaps a thousand feet or less below the promontory. These walls can be reached by a logging road leading up the face of Fort Mountain from Hassler Mills, and the writer examined both walls during the season. Unfortunately, it is not possible to say much regarding them. One is near the trail and is low and straight, appearing to run directly uphill for the trail. It consists of rough stones piled a few feet high. The other, several hundred yards farther along the track, is roughly shaped like an enclosure, again of rough, low stone. The stone seems to have been obtained from a heavy rock fall in the vicinity. They both seem to be very casual affairs, and may have been constructed by settlers who farmed that part of the mountain a half century ago. Certainly they do not appear to be "forts" in any meaning of the word. Dr. A. S. Furcron, State Geologist, has examined these walls and in a letter to the writer states ~~that~~ at least one of them "is the sort of thing that several husky boys could do in less than a day." However, the matter is not clear and these features too might bear examination at a more appropriate season when they can be examined closely.

One final thing might be mentioned in discussing the vicinity of the mountain. A resident of Chatsworth, Mr. James Chambers, informed the writer that about thirty years ago he had seen a well-preserved, semi-circular or "horse-shoe shaped" stone wall at the base of the cliffs on the west side of the summit, somewhere near the road which leads to the talc mine under the peak. From the description this wall would appear to be about 120-150 feet around and from one to six feet high. Some sort of rock-~~was~~ ~~cave~~ ~~is~~ supposed to be nearby. The informant stated that this wall was examined by a Colonel King about that time and reported in one of the Atlanta newspaper (an incomplete search of some Atlanta newspaper files in this respect was unsuccessful). Mr. Chambers felt certain that he could locate the wall on foot, but could not spot it on an aerial photograph and was unable to give verbal directions to pinpoint the area. Because of his age and reluctance to risk the heat and serpents he could not be induced to lead the writer to the site, although he seemed willing to act as guide during the cold weather. It would

be most interesting to investigate this point, since the informant and his account seem quite reliable. It is felt that the matter should be kept in mind during any future investigations, particularly in view of Mr. Chambers' advanced age and the fact that he is the only person alive who is known to have seen this structure.

Conclusions and Recommendations

As far as specific recommendations and suggestions concerning Fort Mountain are concerned, the writer would limit them to the following:

1. To check the rumor of a wall (or walls?) on the west side of the mountain, as reported by Mr. Chambers, as soon as it is possible to do so;
2. To investigate the alleged cave in the Beenive Cliffs when it is feasible;
3. The writer does not feel that it would be profitable to remove further sections of the wall or to make extensive excavations in the area (with the possible exception of "gateway" B), since the chances of recovering archaeological remains are highly unlikely.
4. The writer is inclined to think that there should be no particular effort expended in preserving the pits or holes in the wall. Except as examples of public curiosity or vandalism, these are meaningless and even misleading in terms of the history of the wall.

As discussed earlier, the writer is of the opinion that the wall on Fort Mountain represents a prehistoric aboriginal construction whose precise age and nature cannot yet be safely hazarded until the whole problem, of which this is a representative, has been more fully investigated. Whether its function was ceremonial or utilitarian, this wall is undoubtedly the most spectacular and impressive discovered up to the present, and there is no doubt as to the desirability of preserving and maintaining it. The writer hopes that certain of the more common legends concerning its "origin" have been eliminated in the course of this report; it is most likely that as more work is done on this problem by southern archaeologists the significance of the wall will become more obvious and the phenomenon may then be exhibited to the public for what it is -- an ingenious work of the prehistoric inhabitants of the area -- rather than merely as the enigmatic and somewhat meaningless pile of debris which it is today.

At any rate, the results of the 1955 investigations, both on Fort Mountain and in other parts of the South, are felt to have been highly significant archaeologically. Certainly the Georgia Department of State Parks is to be commended for its willingness to sponsor this particular piece of research on one phase of a problem which archaeologists have ignored until now but which, it is agreed, will become increasingly important as more data are obtained.

Peabody Museum of Archaeology and Ethnology
Harvard University
Cambridge, Mass.
March 5, 1956

II. B. Alec Mountain (Habersham Co., Georgia)

The existence of a stone circle or "fort" near the summit of Alec Mountain, in Habersham County, Georgia, has been noted in several 19th century documentary sources, such as Lanman (1849) and Thomas (1891). It is situated about 7 miles north of Clarkesville, about a thousand feet off the country road leading across Alec Mountain, and appears to be located precisely on the spine of this long ridge.

This site was partially excavated by the writer in June and July, 1956. Two trenches each 5 feet wide and 2 feet deep were dug across the length and breadth of the circles, and a pit 5 feet in depth was dug in the center at the point of intersection. In addition two smaller test pits were sunk in other sectors, one trench was dug outside the wall, and the wall itself was removed in four sections to determine its structure. These investigations are shown on the attached map.

No artifacts were recovered in the course of the excavations, nor were any found on the surface. A great deal of charcoal was observed at depths of about one foot throughout the excavated areas, but this took the form of carbonized roots, most probably burned by natural action. No evidence of hearths or other occupation was observed. Below the 1-foot level the earth, which was the typical North Georgia heavy red clay, appeared undisturbed except for occasional root action. A small rectangle of flat stones near the north end was excavated completely but nothing was recovered, and it might be well to take seriously the information given by local inhabitants that this rectangle was built by Boy Scouts in the last decade.

The form of this structure is that of a broad oval rather than an exact circle. The north-south outside diameter is approximately 107 feet while the east-west length is 92 feet. The wall averages 8 feet in width and 3 to 4 feet in height. The excavations indicate that it was built directly on the original ground surface and has no real subsoil foundations - a feature common to the other structures examined. It is composed of rather small rough stones, easily carried and readily collected from the surrounding surface, piled casually with no attempt at arrangement in regular tiers.

The enclosure is built on a relatively flat area on the spine of the ridge but although a deep gully lies on one side and fairly steep slope on the other it does not give the impression of being a defensive structure. No documentary evidence has been located to justify the local designation of "Old Spanish Fort". It can be easily approached from the south and north directions, and there are a number of other positions in the immediate neighborhood which offer better defensive advantages if such were desired. There is no source of water in the enclosure.

The earliest reference known to the writer concerning this structure is by a traveller named Lanman, who in a book published in 1849 mentions this "fort" and states that either the white settlers nor the preceding Cherokee inhabitants could give any explanation of its origin. That it antedates the Pioneer occupation of the area therefore seems fairly certain.

II. C. Sand Mountain (Catoosa Co., Georgia)

A stone wall on the east side of Sand Mountain, situated on the Catoosa National Guard Rifle Range, was investigated in 1956 after being brought to the writer's attention by Captain Williams, custodian of the range. It is located approximately on the 1200' contour line about a hundred feet below the crest of the mountain.

This wall, or rather walls, are in extremely good shape for most of its length. I am uncertain whether to use the singular or plural forms because short outlying sections of walls have been located which possibly may be directly related to the main section. This main part of the wall, shown on the attached figure, is approximately 27 feet in length and follows a fairly even horizontal course at about the 1200' contour. Its two ends terminate in the vicinity of several rather steep bluffs. For most of its length the wall stands quite vertically on the fairly steep (approximately 45°) slope, although in a few places it has partially crumbled. The thickness throughout is consistently in the neighborhood of one foot, while the height varies from about 1'-2' at the ends to 3'-4' in the central sections. In two places only, at the north end and in the middle, some small area of outcrop are incorporated in the construction. The wall is composed of small, irregularly shaped stones derived from the locality and rather skillfully laid in well-preserved tiers.

At the south end of the main wall, overlooking the steep bluff and heavy rock fall, are five short sections of piled stones which may be tied in to the wall proper. As shown in the figure, four of these run on the same contours as the long wall, while the fifth strikes downhill at right angles to it and through the rock fall debris. It is possible that at one time the whole thing was interconnected and that the intervening sections have been eroded or demolished, but this cannot now be established definitely.

At the north end of the long wall there is, similarly, a number of short wall sections which appear to be extensions through an area of vertical bluffs, heavy rockfalls and huge boulders. There appear to be at least 7 such short sections, at irregular intervals and varying from pieces only a few feet long to one section, at the north extremity, which is at least 50 feet in length and composed of well-laid stones. This section, unfortunately, was discovered quite unexpectedly on the last day of the writer's investigations on the site and has not yet been accurately mapped or surveyed; however, it appears to be the ultimate extremity of the Sand Mountain walls and extends apparently to the north face of the mountain. Beyond that, and on the west side, no traces of walls were noted.

Near the short wall sections at the southern extremity mentioned above are two caves or fissures which appear to be due to water erosion in the limestone. These were examined cursorily but no indications of habitation were observed. Just below the northern end of the main wall is a large rock-shelter which shows signs of recent habitation (burned wood and smoke smears on the walls, due probably to modern hunters) but unfortunately there was insufficient time for the writer to investigate the deposit more fully.

To sum up: the Sand Mountain wall or walls indicate a mildly serpentine construction whose shape seems due to the contours and general form of the mountain rather than to any purposeful representational idea. It does not fit in with our ideas of defensive construction, in spite of its position between two steep bluffs, since at this present height (and there is no indication by way of surrounding debris that it was ever much higher) it would in itself offer little resistance to attackers. Nor does it appear to fulfil any function as boundary line, property marker of earth-retaining wall. There was a homestead on the crest of the mountain until the end of the last century, when the land was taken over by the Federal Government, but this wall does not seem to have formed part of it, either in the way of an animal enclosure or a property line. Queries among local inhabitants of the district provided no direct information concerning the wall, except that one elderly resident states that it "had always been there" in his recollection.

It might be noted here that six of the small stone cairns so frequently found in North Georgia are located on the peak of Sand Mountain. They lie in full view on the west side of the trail approaching the Survey Marker near the peak. One of them was excavated by the writer in the course of the Sand Mountain survey, but no archaeological remains were discovered although the earth was removed to a depth of four feet into undisturbed soil.

II. D. Ladd Mountain (Bartow Co., Georgia)

Until around twenty years ago a large stone enclosure existed on the crest of Ladd Mountain, about two miles from the famous Etowah site near Cartersville, Georgia. During the Depression it was sold by the owner, and demolished for road-building material.

No accurate map or reliable description ever seems to have been made of this construction while it remained in existence. The verbal accounts which are available nowadays vary a good deal, and the writer was not able to trace the original outlines of the "fort" during a visit to the site. The best description, accompanied by a sketch, seems to be that made by Charles Whittlesey during a quick visit to the area and published in the Smithsonian Report for 1881, pp. 627-28:

"On the summit of a rocky hill 2-1/2 miles NW (of the Etowah mounds) which overlooks the valley of the Etowah towards Rome and also the hill country on the south, is an enclosure of loose unhewn stones known as the 'Indian Fort'. It has now the appearance of a heavy stone fence which has fallen down. There are 6 openings or entrances (B,B,B) having a breadth of 10 to 60 feet situated at irregular intervals. It is an irregular oval figure enclosing the rocky summit of the hill, the largest diameter of which is 220 paces and the shorter 200. The elevation of the knob at the center is 50 feet above the terrace of bench on which the lines of loose stones are lying. This interior space is principally cleared of loose stone and shows bare ledges of lime rock in horizontal layers.

"The hill is covered with an open growth of oaks. There is nothing in this structure suggestive of a fort except its elevated position which however is by no means inaccessible. The openings are too wide and too numerous to warrant the idea of a defensive work. It is more probable that it was the scene of imposing public processions and displays and was approached by crowds of persons from all sides through the openings. The rude wall or line of stones would be the necessary result of clearing the ground of the blocks of limestone once scattered profusely over the surface."

A local amateur archaeologist, Mr. Pat Wofford of Cartersville, maintains that when he saw the wall before it was demolished it contained at least three pits or circles built into the wall, presumably of the same nature as those at Fort Mountain. These are not mentioned by Whittlesey or shown in his sketch. A drawing of Mr. Wofford's is attached for comparison with Whittlesey's. It is possible that these pits, like those at Fort Mountain, were of fairly recent origin.

STONE WALLS ON SAND MOUNTAIN
CATOOSA RANGE, CATOOSA CO., GA.

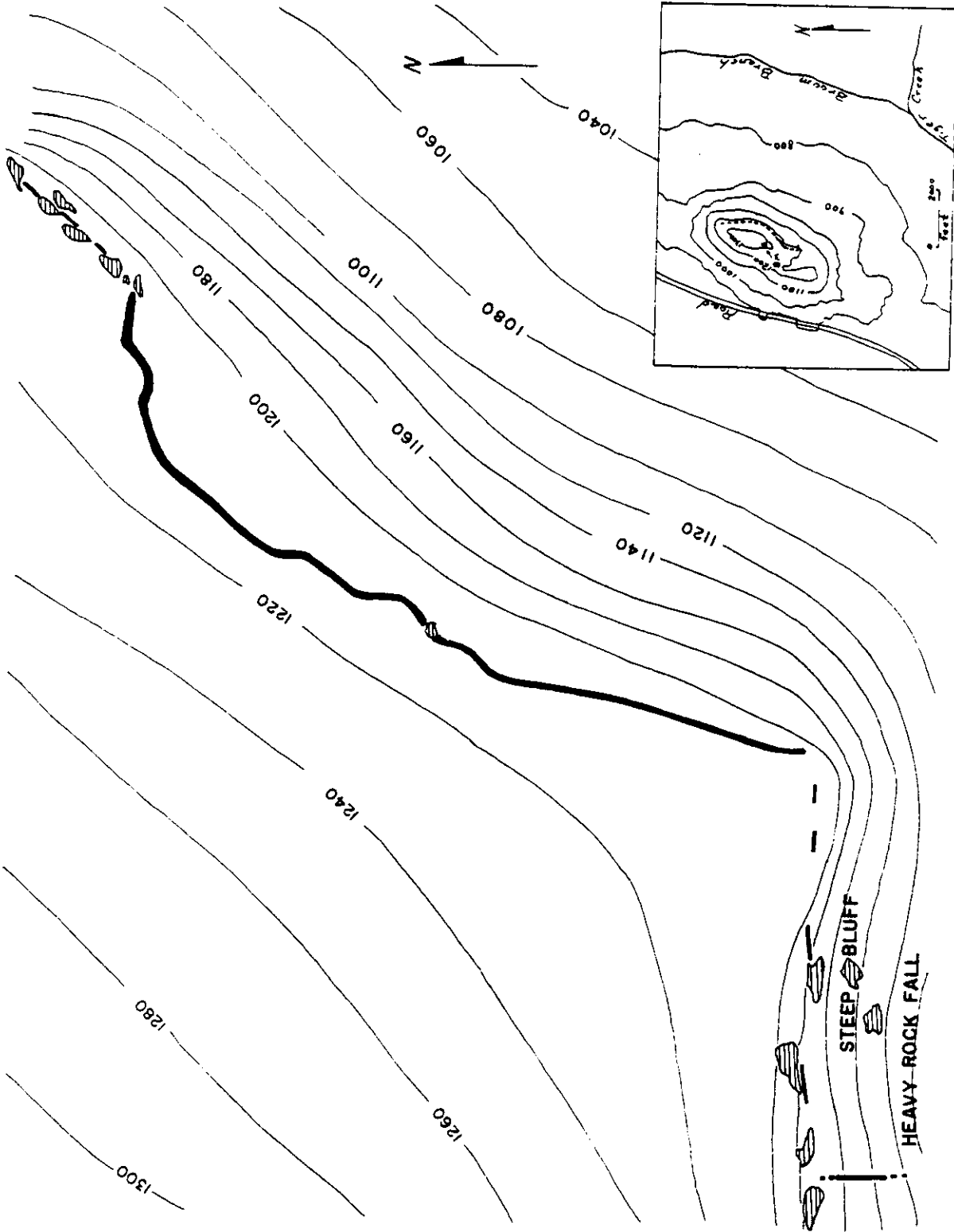

SURVEYED AND DRAWN AUG. 1956 - P.E.S.

It might be kept in mind that this enclosure was only a mile or so away from a large stone mound, known as the Shaw mound and also demolished some years ago. In this horseshoe-shaped mound was found a burial accompanied with copper and stone celts and fragments of a copper breast-plate which Waring (1945) has described as belonging to the Adena complex. However, as yet there is no apparent connection between the two sites.

(This enclosure on Ladd Mountain was also described in the Atlanta Constitution of April 13, 1886, but the writer has not been able to inspect this report up to the time of writing.)

II. E. Rocky Face Mountain Walls (Whitfield Co., Georgia)

In 1956 a number of stone walls were observed on the crest of Rocky Face Mountain, about 4 miles north of Dalton. The main sections of the walls run along the narrow ridge of the mountain, with a short section about half-way down on the west side. The site is reached by a dirt road from the village of Mill Creek in the valley to the west. The walls commence immediately north of Dug Gap but according to several historians have no relationship to the Civil War action fought in the neighborhood.

The walls along the crest are not continuous but are broken up by gaps as shown in the attached map. Because of the amorphous form of some of the intervening stone it is difficult to establish exactly how many wall sections there are, but probably there are seven. Throughout, the walls are composed of medium-sized, casually piled stones with no effort made at layers or tiers. The best preserved section is at the southern end and the construction becomes smaller and poorer as one goes along. The maximum height is about 3 feet, although in some places it is closer to 1 foot, and the width varies from 6 feet to 2 feet. The stones all seem to have been derived from the immediate vicinity. The total length of walls is approximately 1234 feet, but this figure, it should be remembered, includes several short gaps between walls as well as one large interval of 188 feet separating the northernmost section of wall from the rest.

For its entire length the walls skirt along the steep precipices which form the west face of the mountain. Towards the central section, however, the wall has been extended to the very edge of the cliff and part of the outcrop and boulder formation seems to be incorporated into the walls.

The unnecessarily rambling nature of these walls makes it very unlikely that they were intended as boundary markers, and likewise it is difficult to imagine them as defensive constructions. The precipice on the west side of the mountain is sufficiently steep that no wall would be necessary to fight off an attack. Any defensive wall should have been built to guard the east side of the ridge, where ascent is much easier, yet such is not the case here; the walls are aligned along the steep west face and give the impression of being definitely tied in with the steep bluffs and immense rock outcrops on that side.

Several hundred feet downhill from the central section of walls, on the west side and in an area of heavy rockfall and outcrops, a short wall 108 feet long was observed. It is composed of large stones and its construction is much cruder than the walls on the crest. It stands about 3 to 4 feet high, and incorporates a number of small boulders and rock outcrops. Neither its function nor its relationship to the upper walls is evident. Persistent accounts among local residents concerning its use as a defense during the Civil War are not corroborated by historical sources, and a personal examination of its configuration and

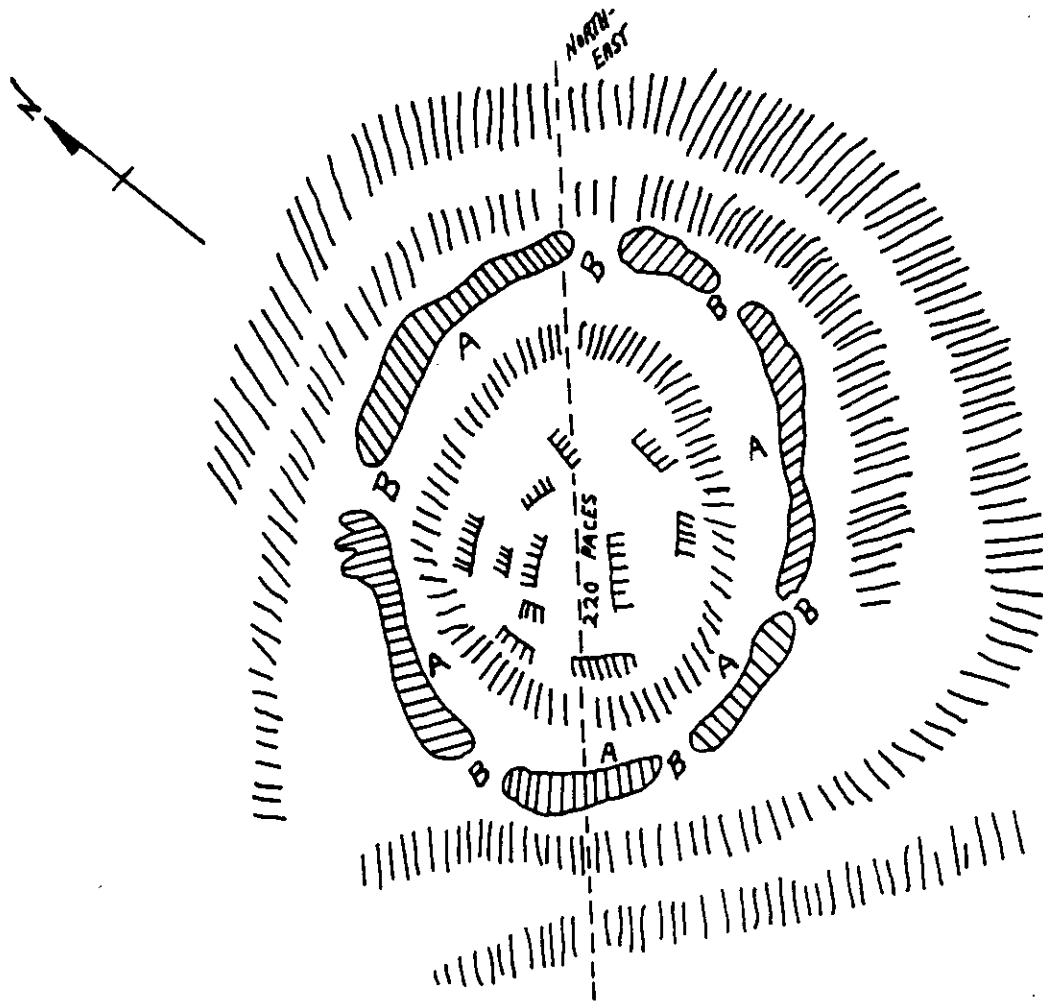

Fig. 1. Sketch of Stone Enclosure on Ladd Mountain, Bartow County, Georgia. Drawn by Charles Whittlesey, in Annual Report of the Smithsonian Institution. 1881, p. 677.

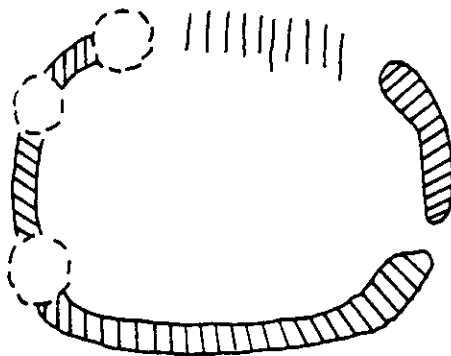

Fig. 2. Outline sketch, drawn from memory, of Ladd Mountain enclosure by Mr. Pat Wofford of Cartersville, Ga., 1956. No scale.

location makes it difficult to accept as a defensive measure.

The crest of Rocky Face Mountain is comparatively narrow along its entire length - averaging 30 to 40 feet probably - and although the whole ridge is covered with trees and brush the soil is rather shallow. There were no indications from surface examination of burial or habitation areas, nor of any clearing or area which may have been of particular significance in terms of the wall itself. Likewise, no artifacts were recovered anywhere near the wall,

II. F. Kensington Wall (Dade Co., Georgia)

In 1955 an extremely well-built stone wall was investigated on a ridge of Pigeon Mountain near McLenimore's Cove, on the farm of Mr. Calvin Fowler near Kensington. This wall is 173 feet in length and extends in an almost straight line southeast-northwest along the crest of a narrow ridge. It stands vertically, except for a few places where it has collapsed, and the height varies from 1 or 2 feet to maximum heights of about 5 feet. The width is a fairly consistent 22 inches. The stone is the flat tabular limestone of which the ridge is composed. This stone breaks easily and regularly along well-defined planes, so that while none of the material of the wall appears to be deliberately cut or worked, the wall though a "dry" one nevertheless has the appearance of a modern masonry job with flat, even slabs. The wall seems to be built on the tabular limestone outcropping, although this cannot be determined definitely without removing several sections of the construction.

The wall begins abruptly at its southeast end and terminates nearly as abruptly at the other end where the crest of the ridge begins to ascend in a series of steps or jogs which continue to a rather flat area of outcrop at the end of the ridge several hundred feet beyond the end of the wall. It is difficult to say whether this flat area, covered with immense stone slabs, has any relationship to the wall itself. Possibly excavation here might be rewarding although some kind of heavy machinery would be necessary for the operation. Some excavation was undertaken by the writer at a point on the side of the crest beyond the northwest end of the wall, where the limestone outcrop seemed to indicate a crevice or chamber, but the investigation disclosed that the peculiar formation was natural rather than artificial. Several feet of the wall were also removed at this end, and this section at least was clearly constructed on the original bedrock or outcrop.

There seem to be no local records or traditions in the neighborhood regarding this wall, and the only tools one can bring to bear on the question of its origin are those of inference and deduction. It seems certain that it has been there for the last half-century at least, since some of the older residents can recall it during that time. There would seem to be no obvious reason for its construction by white settlers, however, for it is difficult to imagine any purpose as a boundary marker or protective barrier against cattle. The area on the crest of the ridge is much too narrow and lacking in soil ever to have been cultivated. Therefore, while the possibility of its construction by an eccentric should perhaps not be completely ruled out, it would seem like the other inexplicable and "freak" occurrences to be best explained in terms of pre-Caucasian occupation.

STONE WALLS ON ROCKY FACE MOUNTAIN
WHITFIELD CO., GEORGIA

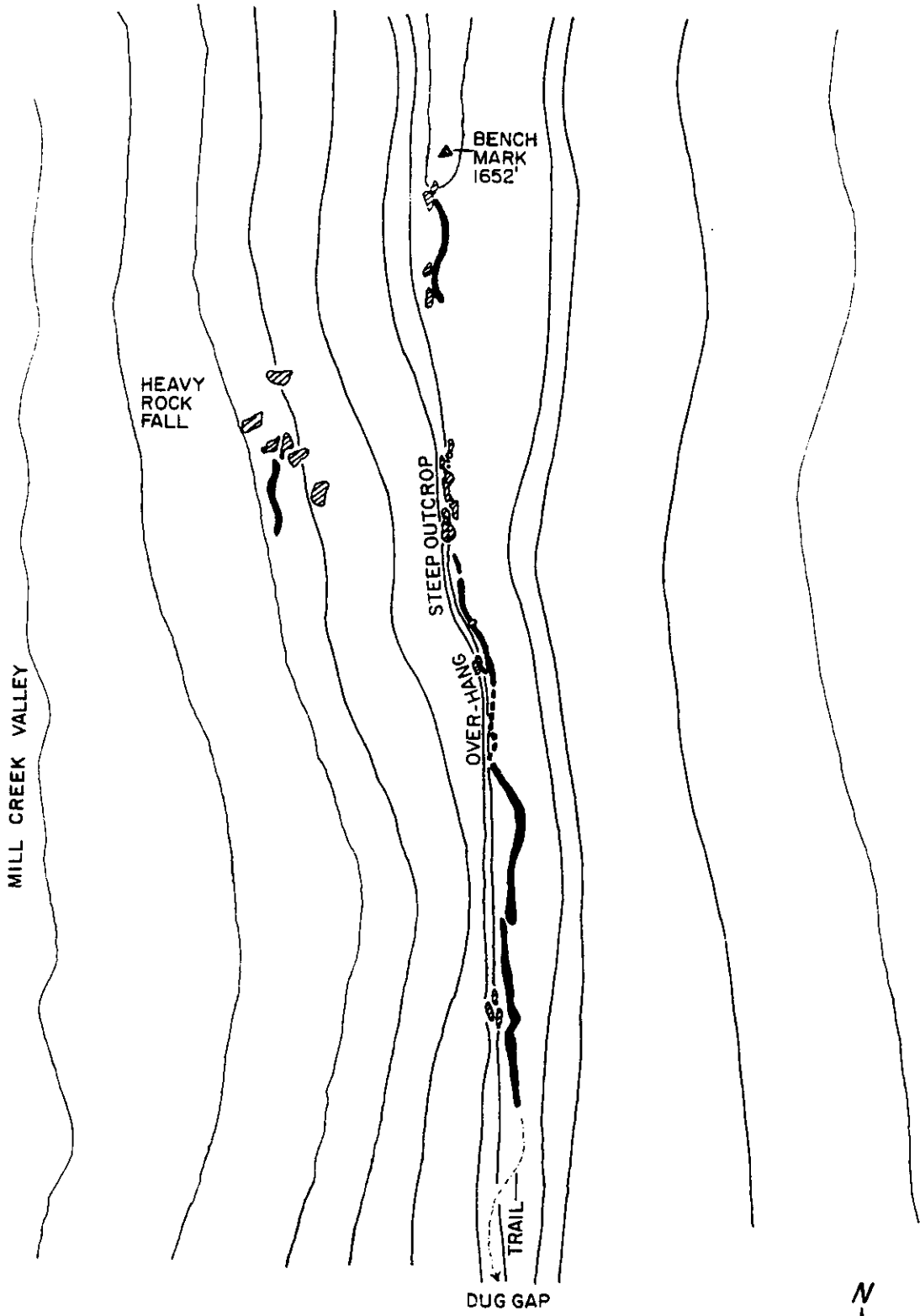

SURVEYED AND DRAWN AUG. 1956-P.E.S.

II. G. Mount Alto (Rome, Georgia)

During 1955 the writer observed two stone walls on the crest of Mount Alto, just outside the city of Rome, Georgia. Both walls are linear in form and extend along the ridge forming the mountain near the site of the television station.

The first is composed of very crude and irregularly-shaped stones roughly piled several feet high and 4 to 6 feet wide. It runs in a north-south direction along the ridge. Its present length is about 145 feet, but the original dimensions cannot be determined exactly since a good deal of the wall has been removed for building purposes in recent years.

The second wall is located about a hundred feet south of the former. It too runs north-south, parallel with the direction of the ridge but is built somewhat below the spine of the ridge on the west side. Its construction is considerably superior to the first, and in most places it stands vertically to heights of 2 to 4 feet (much variation). It is composed of reddish-brown stone, evidently sandstone, as contrasted with the greyish granite of the first wall. The stones are not worked or cut, but are carefully laid to give a smooth external facing. The wall is somewhat curved or bent, and is not continuous at the present time; several portions are almost obliterated, including the central sector, but the total length which can be followed is about 73 feet. The wall does not seem to be linked with any massive boulders or outcrops.

The aboriginal origin of these two walls should be considered with a good deal of caution. Local sources of information have pointed out that this ridge was the residence of a Belgian eccentric named Berchman in the 1880's and 1890's, and that he experimented with fruit-growing and terrace-building as well as laying the foundations for a large house which was never completed. It is possible, although to the writer unlikely, that these walls may somehow be related to Mr. Berchman's endeavors.

II. H. Brown's Mount (Bibb Co., Georgia)

A stone wall on the summit of Brown's Mount, near Macon, Georgia, was unfortunately demolished in the present century and can only be described now on second-hand evidence. It is mentioned by Jones (1873), and in the description from Kelly (1938):

"Local sources are authority for the description of a rock terrace or wall which enclosed a 60-acre tract on top of Brown's mount, opening down to a large spring site. The rocks have subsequently been removed by a railroad for use in riprapping a bridgehead on the Ocmulgee. The descriptions imply the use of the rock and earth enclosures as part of an aboriginal scheme of fortification. Exploration to afford archaeological indications of this theory have not been carried out to date. Brown's Mount, on the basis of existing data, is strongly indicated to be related to the earlier prehistoric horizon at Macon Plateau.

"In fact, the apparent absence of complicating superimposition of cultural remains at Brown's Mount might simplify site checking on many of the problems uncovered at Macon Plateau. It is worthy of note that preliminary survey and reconnaissance have shown only two sites, Macon Plateau and Brown's Mount, as representative of the older prehistoric level in central Georgia."

It is unfortunate that no sketch or diagram is available to indicate the precise configuration of this occurrence. Judging from the above description, however, it would appear to be a phenomenon similar to others treated in the present paper.

STONE WALL NEAR KENSINGTON, GA.

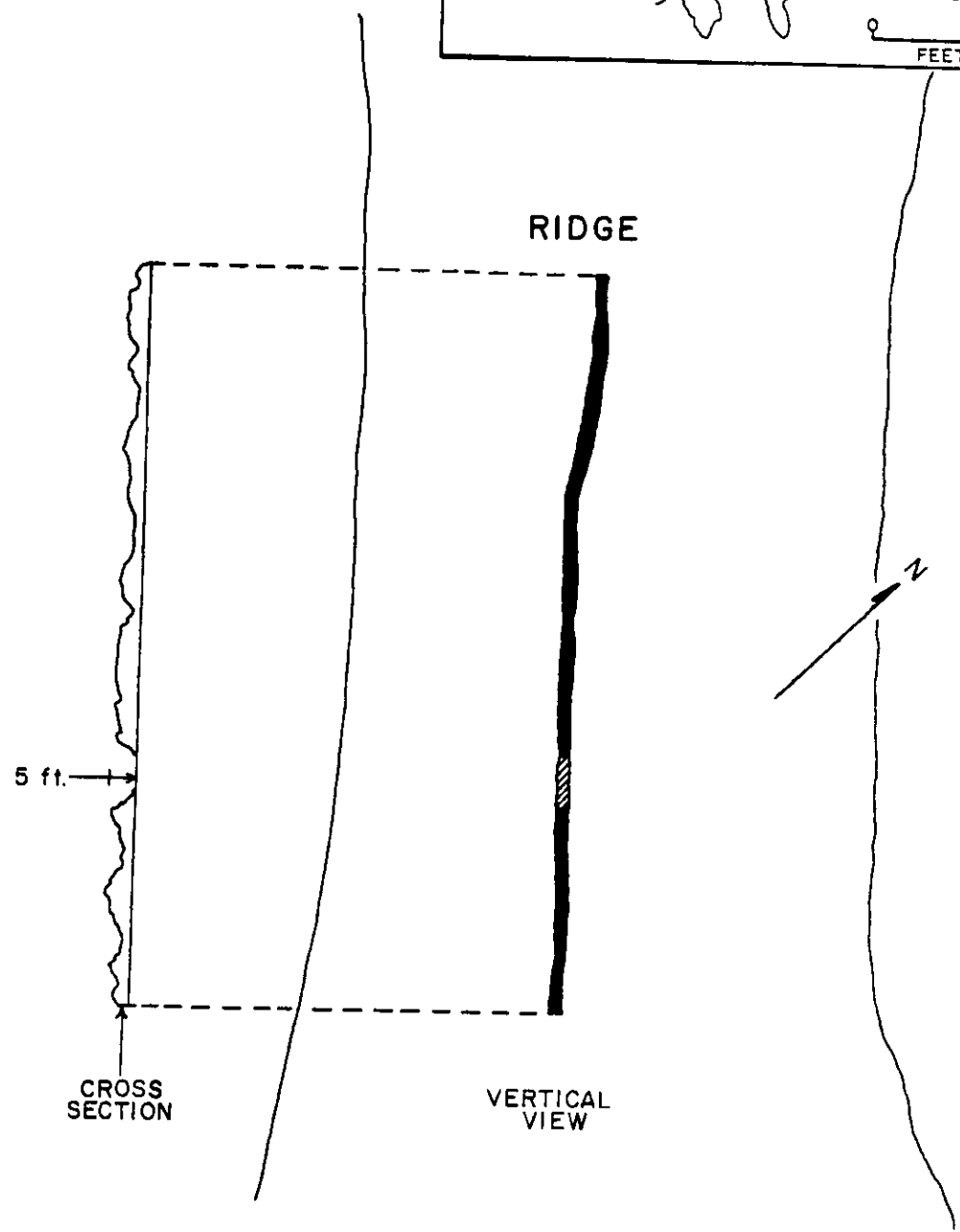
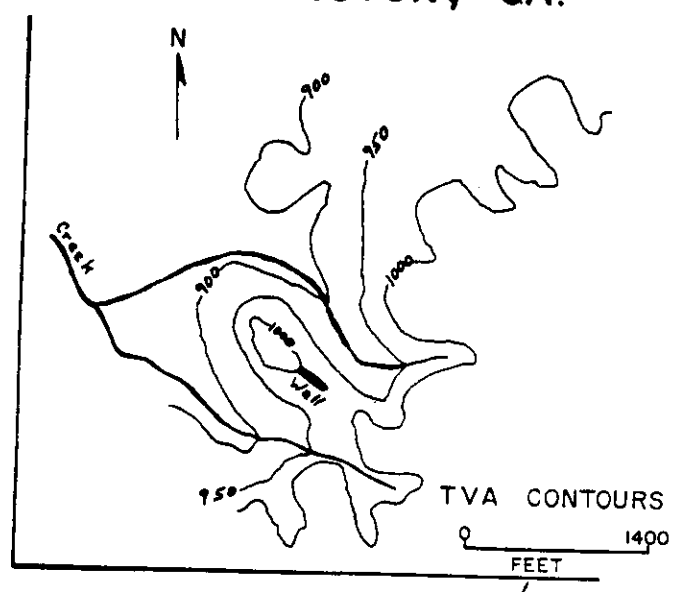

SURVEYED AND DRAWN 1956. P.E.S.

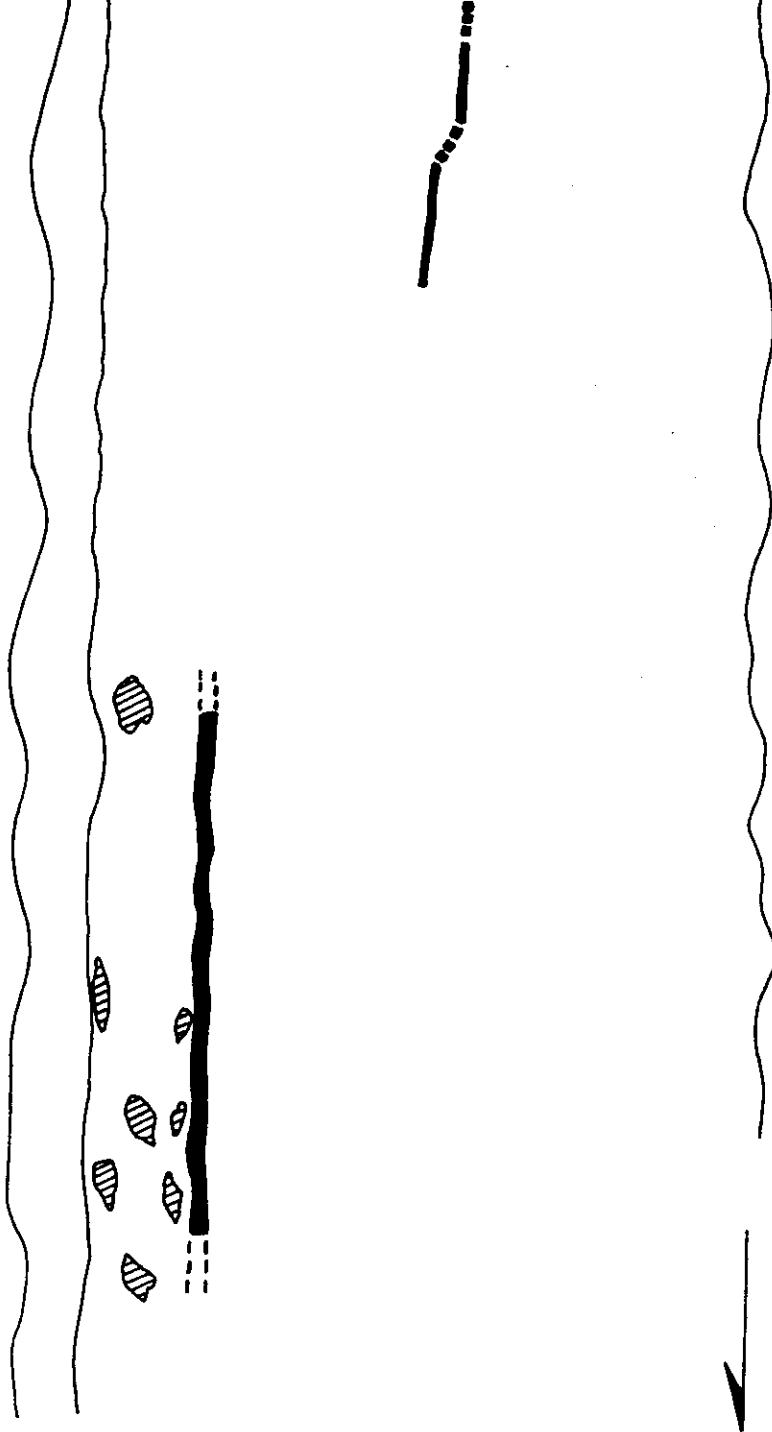

STONE WALLS ON MOUNT ALTO, ROME, GA.

--- QUESTIONABLE CONSTRUCTION
/ / / LARGE BOULDERS AND OUTCROPS

0 30 60
FEET

SURVEYED AUGUST 1955
DRAWN AUGUST 1956-P.E.S.

II. I. Lookout Mountain (Chattanooga, Tennessee)

In many respects the structures immediately below the west face of Lookout Mountain are the most puzzling of all those examined to date. They consist of at least three sections of stone walls and at least 20 stone "circles" or "rings". These constructions are located in the Lookout Mountain part of the Chattanooga-Chickamauga National Military Park, and have usually been attributed to the Confederate forces during the Civil War. In fact they are so captioned by the park markers, and the circles are officially known as the "Confederate Rifle Pits."

Until quite recently this origin has not been questioned, but since the spring of 1956 a re-examination of the whole matter by several Civil War specialists, particularly Mr. Gilbert Govan of the University of Chattanooga, reveals that no historical basis is known for such claim. Apparently the label was stuck on when the Park was set up in the early years of this century, as a result of a casual remark by one of the Civil War veterans who had taken part in the battle. The report of the Confederate Brigadier-General E.C. Walthall, who occupied that part of the mountain in the period of September-November, 1863, states that "my predecessor" built the walls and circles. But, although Walthall was evidently unaware of the fact, he apparently had no predecessor - he was the first Confederate commander there and therefore the structures must have been in place before then. Further doubt on their Civil War origin is created by the Confederate engineers' reports for that part of the mountain, which state that it was not feasible to construct a defensive line there.

But even setting aside all documentary sources, a close examination of the works do not substantiate a military or defensive function. The walls are too carefully laid, for the most part, to have been hurried or emergency measures. The main section of the wall is a somewhat rambling affair approximately 415 feet in length. It is composed of loose, rough stones piled to an average height of 3 feet. It is difficult to see its defensive worth, since it makes no particular effort to follow strategic contours or to incorporate a number of useful rock outcrops. Its original height, judging by the present debris, was never much higher than it is now, and certainly this is hardly high enough for any really effective defense. In particular, it is too high to serve riflemen lying prone and too low to protect them while kneeling. There are two additional short outlying sections of wall, as shown on the figure; one of these may have originally been a projection of the main wall, but the relationship of the short section of wall to the east is questionable.

The stone "circles" (some of them are really semi-circles or oblong enclosures) are equally dubious as rifle pits, fox-holes or defensive works of any kind. Their irregular and scattered locations are hard to explain in defensive terms, for one thing; some of them are exposed on all sides while others are blocked off by boulders on the downhill side, which presumably would be the direction of any attack. Their size varies greatly also, from a minimum diameter of 5-6 feet to a maximum of 16 feet. Most of them are clustered together in a central position, and in

fact three of them are built together rather like the advertising trade-mark for a certain brand of beer. In the case of several, their locations along certain contours would make it quite simple for attackers to slip up on the circles while under cover of the large boulders in the vicinity.

All in all, the hypothesis of a defensive function for the circles can be discarded. It is likewise not possible to accept them as hut foundations or tent weights; they are for the most part too heavy and substantial for this, and in addition the position of several directly under the sloping sides of large boulders would mean that in the event of a rainstorm any inhabitants of the circles would be flooded out. In the same way, the small size of others does not support the suggestion that they must have been horse or livestock corrals.

The height and state of preservation of the circles shows a wide variation. Twenty of them are in excellent condition, made of well laid stones ranging from one to three feet in height, with an average of approximately two feet most common. The other nine which have been examined and mapped, however, are in rather poor shape and appear to have been badly damaged by root action, windfalls and erosion. In a number of cases it is difficult without very close examination to determine whether they really are circles of merely accidental occurrences of loose stone. It is fairly certain that a number of other circles which originally existed have suffered so extensively that they can no longer be distinguished by surface remains.

With the defensive function of these constructions ruled out, two important questions are still to be raised: (1) what was the relationship, if any, of the stone walls to the circles? and (2) what was the purpose or function of the entire configuration? This, unfortunately, cannot be answered at the present time. No artifacts are known to have been recovered from the surface and excavations in two of the circles (nos. 4 and 24) revealed no evidence of occupation, disturbance or use. It is possible of course that more intensive archaeological excavation than was possible by the nature of this year's project can provide us with the material evidence which would be so invaluable in understanding the temporal and cultural significance of these constructions. In the meantime, it might be mentioned that these circles appear to be a unique occurrence in this area and no others have so far been brought to the attention of this survey.

However, it is interesting to note that somewhat similar occurrences have been reported from the Great Plains regions of Wyoming, Montana, and the Dakotas (Mulloy, 1952, p. 137). Here low stone circles of from 5 to 40 feet in diameter occur either in groups or singly. Some are simple circles; others are eccentric. Although locally described as "tipi rings", they do not appear to such: few artifacts are found in or near them, there are no fireplaces or signs of habitation and they lack packed earth floors. They may be related to the "medicine wheels" of the region which are stone

LOOKOUT MOUNTAIN NEAR CHATTANOOGA, TENN.

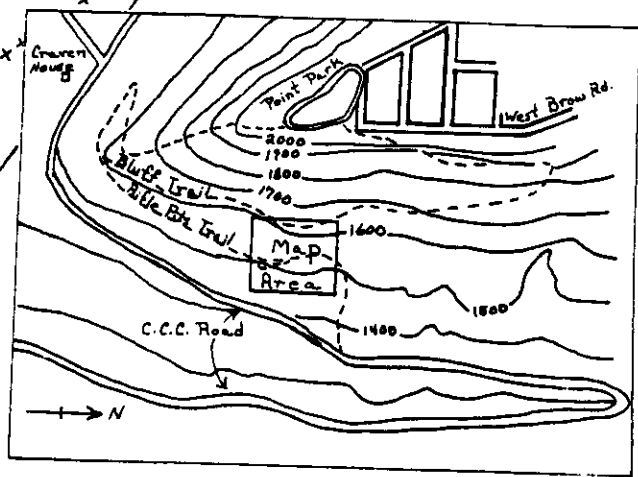
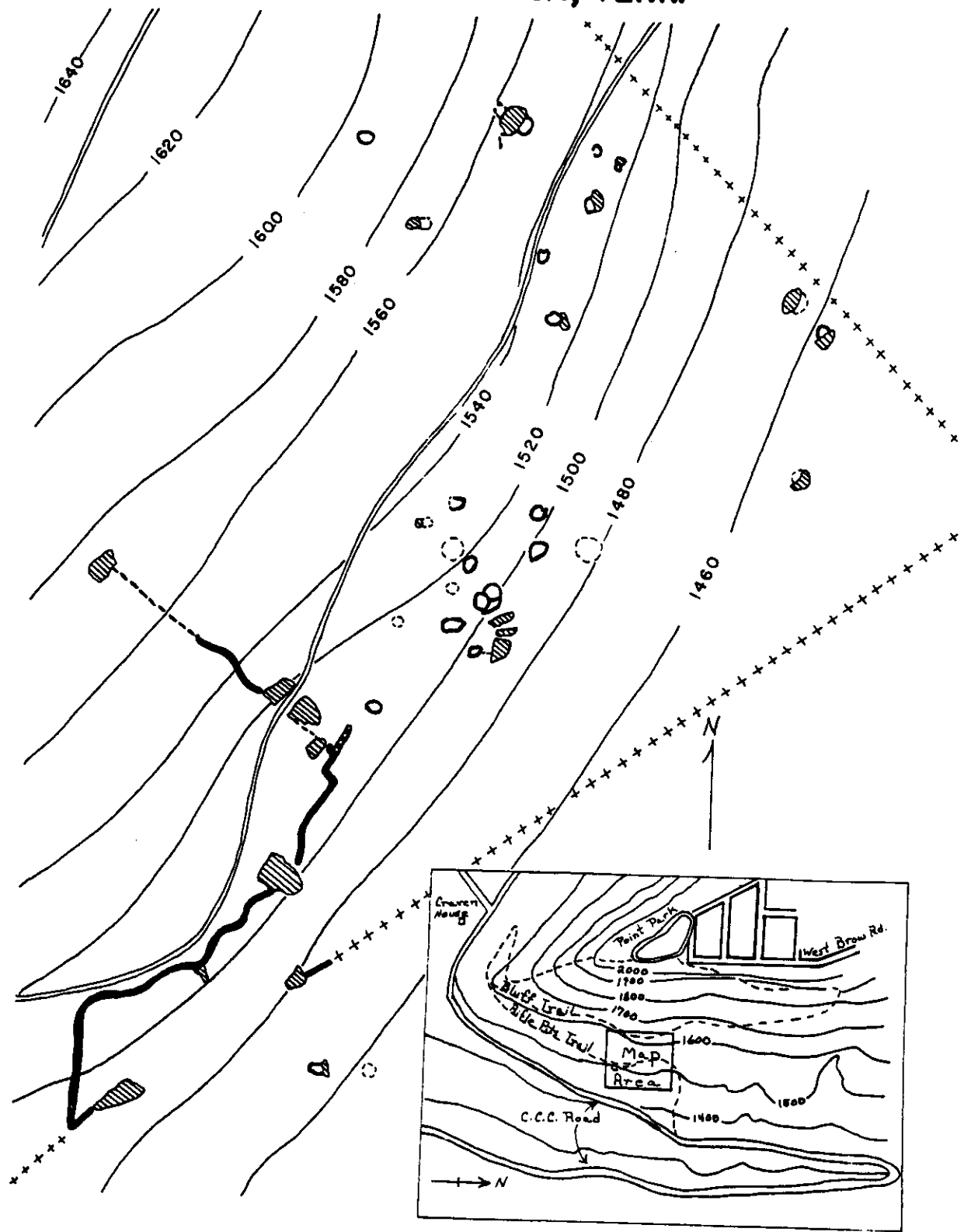

- +++ WIRE BOUNDRY FENCE
- QUESTIONABLE CONSTRUCTION
- ▨ LARGE BOULDERS OR OUTCROP

T.V.A. CONTOURS SUPERIMPOSED

SURVEYED AND DRAWN 1956 P.E.S.

circles with spoke-like lines of stones, and small irregular dry masonry walled structures. Stone cairns and mounds, some containing burials, and lines of stones are known from the same district but they have been investigated apparently, like the "tipi rings" and cannot be dated with any certainty. While no connection with those in the Southeast is implied here, it remains an interesting parallel which might be kept in mind in evaluating the significance of the Lookout Mountain circles.

II. J. De Soto Falls (Alabama)

Two stone walls have been recognized for more than a century at De Soto Falls, on the Little River in northeast Alabama at the end of Lookout Mountain. They are described at some length by a missionary from the Brainerd Mission at Chattanooga in 1823 (Walker, 1941, pp. 31-32), and, curiously enough, a volume dealing with archaeological explorations in Yucatan (Norman, 1849, pp. 169-70) also gives a rather full description.

The walls have been looted in recent years for building stones by residents of the district, and about all that remain today are to low windrows of stones mixed with earth. They enclose a steep promontory which extends out towards the Little River, as shown in the figure. The outer wall is approximately 600 feet long, and the inner one is in the neighborhood of 500 feet. A ditch had been built in front of the inner wall averaging several feet in width and one to two feet in depth (Roberts, 1949). At present the width of the walls varies from 4 to 8 feet, but originally it is estimated that the height may have been about 4 feet. It is built up of flat sandstone slabs from the vicinity.

The bluff or promontory which the walls enclose has a vertical drop of about 50 feet to the river bed below. Immediately below the edge of the bluff are a series of caves or shelters formed by connecting chambers in the rock. They can be reached by a path from above. There is no record of any archaeological material having been recovered from these caves or from the area inside or around the walls. There would appear to be more basis here for describing these constructions as a fortification than at most of the sites heretofore examined, and the possibility that the caves were refuge places should be kept in mind. In any event, the absence of artifacts or other cultural remains neither encourages nor excludes the entertainment of other interpretations.

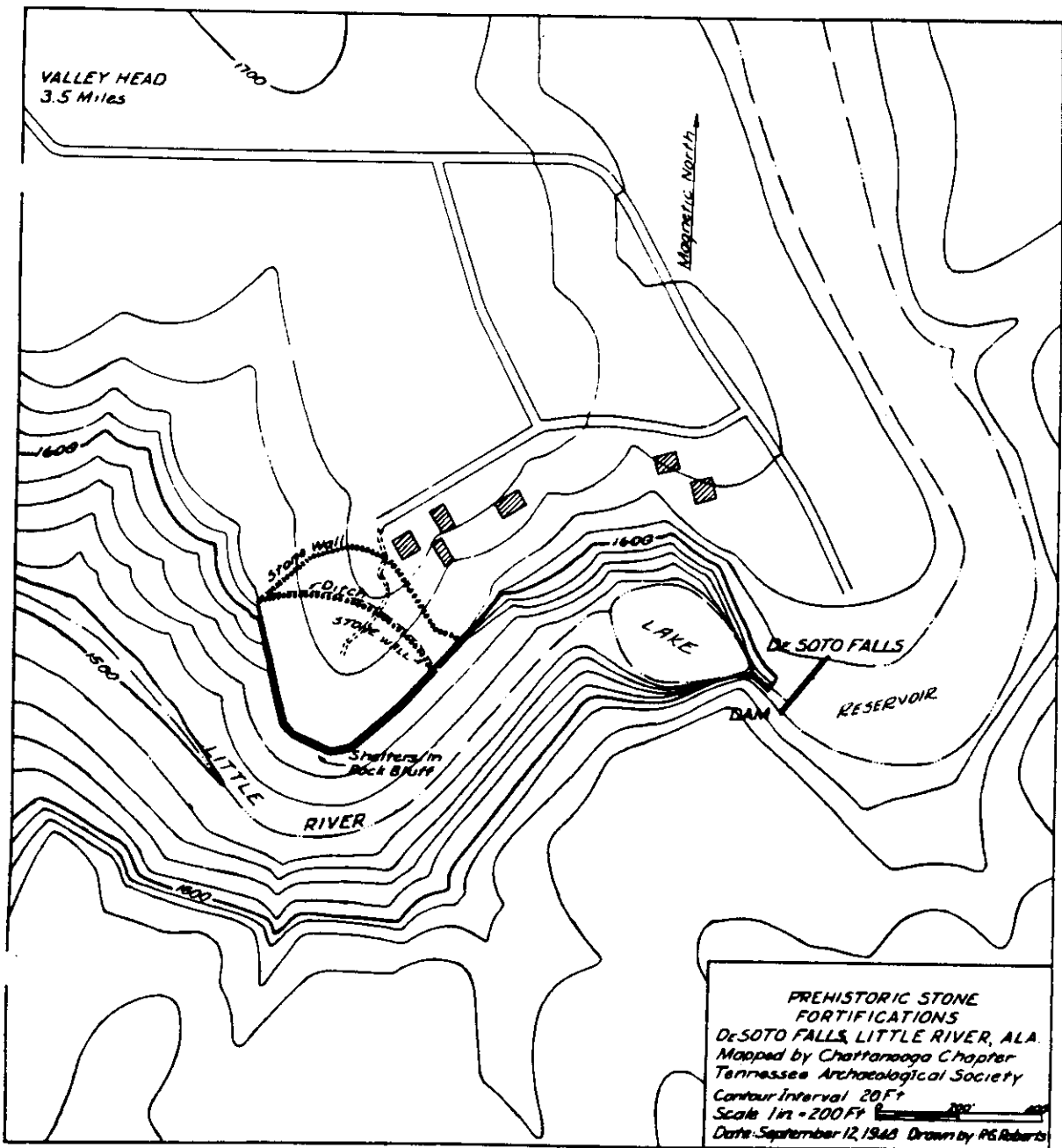

TURN THE PAGE FOR EDITORS NOTES

EDITORS NOTES

The author, Philip E. Smith, had not seen Ralph B. Roberts' description of the De Soto Falls site, as reported by Roberts in *Tennessee Archeologist*, Volume V, No. 2. He had independently studied Robert S. Walker's Lookout, The Story of a Mountain, (1941), which recounted the description of a Brainerd Mission visitor in 1823. Smith also quotes a source not mentioned by Roberts, i.e., (Norman 1849, pp. 169-70). His account closely parallels Roberts' description based on the 1948 visit of the Chattanooga chapter of the Tennessee Archeological Society, to the site. Both writers are cautious, replying that the stone features are aboriginal rather than early settler's hasty construction, but offer no hypothesis as to the purpose of the rock walls.

II. K. Walls in Madison Co., Kentucky

Several extensive stone walls, usually described as "forts" have been reported from the vicinity of Berea, in Madison County, Kentucky. The present writer has not examined them and the bulk of the following description is derived from the accounts and maps in Burroughs' Geography of the Kentucky Knobs (1926) and from personal correspondence with Professor Burroughs. Brief descriptions are also given in Young (1910) and Webb & Funkhouser (1932).

(1) Indian Fort Mountain

The series of walls on this mountain can easily be imagined to be fortifications, and indeed they may well be. A total of 17 walls, varying in length from 20 or 30 feet to over 1200 feet, encloses an area of 200 acres at the top. Of these 17 walls, 8 are perpendicular while the rest are merely described as "stone barricades." In general the walls are curving or crescent-shaped. The heights also vary, from low lines of stones up to 12 feet. The ends of the walls are tied in to cliffs and rock outcrops.

In most of the cases the walls are built at the heads of gullies or breaks in the perpendicular cliffs which are from 50 to 200 feet high. For this reason it must be admitted that a fortification thesis hold more water here than at most of the wall sites described heretofore. On the other hand, the series of long walls at the southwest corner (Nos. 2 and 5) do not appear defensive structures, and it is possible that these were the original, non-defensive constructions while the lesser walls in the breaks of the cliffs were built later for strictly military purposes.

A number of rock-houses or caves are located in the cliffs near the walls, and several burials were uncovered by Burroughs. Unfortunately, the information is vague and although pottery was found it was not described or illustrated.

(2) Basin Mountain

The main walls on Basin Mountain are about a half mile northeast of the north end of the walls on Indian Fort Mountain. This main section is V-shaped, 465 feet long and located at a break in the steep cliffs which girdle the mountain summit. It certainly does have a defensive flavour. At some places the wall is 5 feet high and 7 feet across.

About a thousand feet west of this V-shaped wall is a shorter section, quite straight and 220 feet long extending along a sloping ridge. Its height varies from 2 to 4 feet, and no function, military or otherwise, is ascribed to it by Burroughs.

The cliffs around Basin Mountain have a number of caves which have not been extensively investigated. An earth burial mound is described near one of the caves, but there is no further description. In any event

it would be difficult to tie in the habitation sites or burial sites with the walls themselves. The same thing goes for a mound several miles away from these two mountains, near Berea, where a burial containing copper "breastplates" was excavated; it is tempting but imprudent at this time to jump to any quick conclusions about the relationships between the walls and the burials.

II. L. Mount Carbon (West Virginia)

Near the summit of Mount Carbon, just east of Montgomery in Fayette County, West Virginia, is the so-called "wall site," designated as 46-Fa-1 by its describers. It is located on the top of a mountain on the southwest side of the Kanawha River, in country which is thickly covered with Adena deposits. The writer has not visited the site, and the following description is a summary of information given in a talk by Mr. Joseph Inghram to the West Virginia Archaeological Society in 1953. The accompanying map was prepared by Mr. Sigfus Olafson, President of the West Virginia Archaeological Society.

The principal features of this site are a series of stone structures locally called "walls," a number of stone mounds or cairns, flint quarries, workshops, probable camp sites and graves. The walls are in reality low windrows of stone, generally about 25 feet wide and 2 to 3 feet high, composed of sandstone obtained from numerous outcrops or gathered from the surface of the ground, and occasional blocks of Kanawha Black Flint. Mr. Inghram believes that "there is nothing about their appearance to indicate they were ever walls as we commonly understand the term."

There appear to be 4 main walls, judging by the description, although only 2 of these are shown on the map. Number 1, on the north end and slope of the hill, is now about three-quarters of a mile long but may once have been two miles in length before erosion and demolition took place. It is not indicated on the map.

Wall Number 2 is roughly U-shaped with a clear and distinct outline. It is situated across a narrow place on the ridge about a half mile south of Number 1. A stone cairn is located nearby.

Wall Number 3 is on the same ridge but 3035 feet south, and is the largest and best defined of all the windrows. It is fully 22 feet wide and 3 or 4 feet high on the ridge, which it also crosses at a narrow point. Like Number 2 it is roughly U- or rather V-shaped, but much longer. About 21 stone cairns, some disturbed, are located just south of here.

Wall Number 4 is about a mile south of Number 3, and is not shown on the map. It has not been well investigated, and may not even belong to the same group as the other three. Apparently it is almost as large as Number 3.

It is difficult to draw conclusions from the various artifacts recovered from Mount Carbon, whether from the surface or the cairns. No pottery whatsoever has been found. The artifacts, all crude, include a few projectile points, flint blades and many granite hammerstones. Mr. Inghram suggests that the projectile points are definitely not Adena but rather resemble the Archaic Guilford material from South Carolina. They also imply that the construction of the walls and cairns may have been in some way related to the nearby deposits of Kanawha Black Flint. It might also be kept in mind that the Kanawha River (via the New River) is the only

one which cuts entirely through the Alleghanies and thus was an important prehistoric communication route.

To attempt to sum up the Mount Carbon situation is not easy, especially when the site has not been inspected in person. Apparently neither the location nor the construction of the "walls" give much support to a theory of defense. Quite probably the walls were linked to the stone cairns and occupation sites found nearby, and if this is so certainly Mount Carbon would be a very promising locale for future archaeological investigation.

III. Summary and Conclusion

The foregoing corpus of descriptive data represents the raw materials from which conclusions must be drawn. The following section is a perhaps abortive attempt at interpretation of these data in the light of the sketchy and limited facts on hand at the present time. It is needless to point out that this "interpretation" is highly tentative and speculative, and perhaps need not be taken too seriously. Almost certainly it will be modified as more information is obtained, but it seems worthwhile to make some attempt at interpretation, however tenuous, at this time if only to provide a jumping-off point for future investigation.

It will be obvious by now that one serious flaw in the line of reasoning presented here lies in the assumptions, wholly unfounded at the present, that the various stone constructions described represent a related complex of prehistoric cultural behavior on a contemporary time horizon, or that they indicate a symbolic concept which maintained a cultural tradition over a long period of time and throughout a large spatial area. Neither of these assumptions would, of course, disallow the possibility that a single definite group of prehistoric people were responsible for the structures; conversely, it also allows for the possibility that they may be the artifacts of groups of people totally unrelated in time and space but sharing certain elements of tradition of which these structures are visible manifestations. But these assumptions, it must be emphasized strongly again, are still in the "not proven" stage, and nothing concrete in the investigations thus far has been able to tie the various phenomena together more closely. We are still operating on little better than hunches. But, even if we gloss over this barrier and work on the assumption that the phenomena are related, we are still almost as much in the dark as ever as far as getting at the inherent meaning of the structures is concerned. Even if we knew for certain that a certain group of people in a certain period built them, there are still some difficult handicaps in determining just what were the attitudes or concepts or beliefs in the minds of these people which compelled such behavior.

It is difficult, for one thing, to isolate common factors or common peculiarities in the physical forms or locations of the constructions. Some are quite or nearly linear in shape (e.g., those at Rome, Kensington, Rocky Face Mountain), others are curvilinear or zigzagging (Fort Mountain, Sand Mountain, Lookout Mountain), and still others form enclosures as at Ladd Mountain, Alec Mountain, Mount Carbon, Brown's Mount. Some are well and skillfully built of material which is evidently carefully selected, while others are merely alignments of loosely piled stones which hardly deserve the designation of walls. At one site (Lookout Mountain) it is not even possible to say definitely that separate configurational forms (in this case the walls and the stone rings) are related to each other.

Apparently the one major feature common to all the constructions described is their location in "high places," on or near the crests of hills and mountain. Here, however, it might be worth noting that at one site briefly

visited by the writer in 1955 (Devil's Half Acre in Putham County, Ga.), a long, well-built linear wall is constructed on comparatively level terrain in a lowland region. Unfortunately it has not yet been possible to survey and describe this interesting site in detail.

It has become something of a standing joke among archaeologists to maintain that when a phenomenon cannot be explained in any other way it can always be labelled "ceremonial" and allowed to go at that. This is taking the easy way out, of course, and in many cases it does represent sloppy or unimaginative thinking. Therefore, we realize that we are leaving ourselves quite vulnerable to attack and criticism on this score when we suggest that, in our opinion, the structures under discussion are ceremonial in nature, or at the very least represent some form of symbolic rather than strictly utilitarian behavior.

It must be admitted that our grounds for harbouring this feeling are mostly negative. None of the phenomena appears to have any "useful" function, whether in terms of defense, boundary markers, game corrals, etc. Here, of course, we may be guilty of the rankest ethnocentrism in judging them in our own terms and failing to allow for customs or idiosyncrasies, wholly divorced from the religious or ceremonial, of the makers. But we can always plead that this is the best we can do.

The failure to recover artifacts in or near these remains (unless the artifacts found near the Mount Carbon, Madison County and Brown's (Mount walls are pertinent to the constructions) has been a disappointing stumbling-block in our attempts to define them, but at least this failure has to date been consistent. This may in itself be significant, however. It may not be too unreasonable to entertain the belief that conscious efforts were made to prevent the intrusion of the profane objects of everyday life into these places.

As mentioned before, there is no common theme or characteristic running through the physical form of all these structures except for the facts that they are all made of stone and with one possible exception are located on elevated ground, which may be merely incidental factors explicable in terms of the raw materials available and the local terrain. We also have to consider the possibility that in more senses than one we may be biting off more than we can chew; in other words, perhaps we are lumping too much together under a single category, and if some of the sites described above were deleted or ignored the results might be more consistent and common factors could be isolated and defined. But just how to pick and choose our phenomena is another problem, and at this early stage of the game it is probably better (not to mention easier) to lump than to split.

But there seems to be a suggestion at some of the sites that one common idea may have been present and in some degree perhaps responsible for the structures. At a number of the sites, particularly Fort Mountain, Sand Mountain, Lookout Mountain, Rocky Face Mountain, and possibly Kensington, Brown's Mount and Ladd Mountain, one of the most striking features is the apparently deliberate purposefulness by which large boulders and outcrops

were tied in with the walls. In some cases the walls seem to make deliberate detours to link themselves with the larger rocks. Also striking at some of the sites is the suggestion that conscious effort was made to link widely-scattered area of steep bluffs together by means of the walls. One is thus led to consider the possibility that this may have been the real raison d'etre of the walls - to link certain impressive natural phenomena such as boulders or bluffs which may have held some religious, symbolic or animistic significance to the people concerned. Whether the gross configurations of the structures - e. g., the serpentine forms of the Fort Mountain and Sand Mountain wall, the straight lines of some others, the enclosure forms of still others - have meaning or significance is a question which can be raised now but unfortunately cannot be answered. The same goes for speculations concerned with the significance of possible astronomical alignments and bearings; to date we do not have a sufficiently large reservoir of data to apply to the conjectures.

The situation when it comes to dating these constructions is quite as unsatisfying. The only ray of light here comes if we take the perilous course of assuming that the walls, enclosures, etc., are related to the stone effigies and stone mounds found scattered throughout much the same area of the Southeast. For example, Putnam County in Georgia contains two well-known bird effigies of stone which might have some relationship to stone walls in the area (Jones, 1877). The large "eagle" near Eatonton was partially excavated in 1954, and a human cremation and some quartz implements resembling those of the Old Quartz Industry were found (Petrullo, n.d.). During the destruction of a large stone mound at nearby Presley Mill, a human skeleton was discovered in association with a finely ground and laterally perforated stone or pendant of roughly football shape. A stone mound from Lumpkin County, in north Georgia, yielded a projectile point very like those found elsewhere in north and northeast Georgia and attributed by Caldwell to Old Quartz (Kelly and Beam, n.d.). The discoveries made at the Shaw Mound near Cartersville, Georgia (Waring, 1945) have already been mentioned, and apparently the artifacts found here show Adena-Hopewell affiliations. Fairbanks (1949, 1952) has pointed out that the scanty evidence recovered from certain of these stone effigies and mounds in Georgia belong to the Mossy Oak complex of simple stamped pottery, which in turn seems to be contemporary and possibly related to the Copena complex of Tennessee and the more widespread Adena. Jennings (1946) has described a stone mound near Nashville, Tennessee, as showing Copena affiliations. This, if accepted, would seem to place the mounds and effigies well back in the Late Archaic - Early Woodland period, as understood at present. Interestingly enough, there is some corroboration of this Southeastern estimate in Pennsylvania and Indiana where a number of excavated stone mounds have revealed Adena affinities (Dragoo, 1955).

It might be worthwhile to mention here that Waring, in conversation with the writer, has pointed out the rather striking parallel between the stone circle (described above) in Habersham County, Georgia, and the large shell rings up to 300 feet in diameter on the Georgia coast, particularly on Sapelo Island. Like the Habersham stone circle, the shell circle on Sapelo was quite devoid of artifacts apart from very recent intrusive objects, but stray sherds found in the shell walls are of plain fiber-tempered

pottery indicative of a Late Archaic position. Perhaps the parallel is a specious one, but it might be well to keep in mind the possibility that the two occurrences are regional variants or manifestations of equivalent concepts.

If, then, the stone walls and enclosures do go back to the antiquity suggested by the material from the mounds and effigies, some interesting implications are involved. Certainly the factors inherent in the dynamics of these stone constructions - for some of these structures are truly megalithic undertakings, whose erection must have demanded a good deal of intensive and thus presumably organized labor, with all this implies in terms of the usual concomitants of group cooperation, social leadership and class differentiation, etc. - would provide some extremely intriguing sidelights on the socio-cultural life of this early period.

But, as repeatedly emphasized here before, the reasoning employed in postulating a link between the stone walls and enclosures on the one hand, and the stone mounds and effigies on the other, is rather fragile and as yet will hardly in itself support the weight of any elaborate hypotheses strung upon it. For the time being the theoretical side of this problem should be preserved as flexible as possible until more field data, buttressed by excavation where feasible, are available. One swallow, or even several, do not make a summer, but, to switch metaphors, there seem to be straws in the archæological wind which possibly point in the right direction.

IV. APPENDIX: Miscellaneous Constructions

In addition to the sites described in the main body of this paper, there are a number of references in the archaeological literature to stone walls, enclosures, "forts", and the like which may possibly be pertinent to the problem we have in mind. Some of these references are given in the following section, together with the documentary sources. They have not been examined by the writer, and very possibly many of them are no longer in existence; nevertheless it is felt that collecting them in the present paper may be of some assistance to future investigators in this fields, since undoubtedly certain of them sound as if they deserve further attention.

Besides the examples culled from documentary sources, several occurrences which have been briefly examined by the writer but which there was no opportunity to investigate properly are included in this Appendix.

GEORGIABartow Co.

A mound (earth?), encircled by a stone wall at Adairsville. Reference: Thomas, 1891, p. 45.

Dade Co.

(1) "On the farm of Col. Perkins there is a stone fort, enclosing three or four acres, of which the Indians were unable to give any account."

Reference: White, 1849, p. 213.

(2) During 1956 the present writer briefly noted a short but heavy section of stone wall at the foot of Lookout Mountain in Setton's Gulch, between Trenton and the Mountain. It is located on sloping terrain near a cave well known to local speleologists. Circumstances made an accurate survey impossible, but the wall does not seem to comply with any modern need and possibly it merits closer study.

De Kalb Co.

Jones (1873, pp. 207-208) mentions the remains of a stone wall half way up the side of Stone Mountain. However, no trace of this remains, according to Dr. A. R. Kelly.

Douglas Co.

White (1855) refers to "ancient fortifications" on the western bank of the Chattahoochee River opposite the village of Campbellton. This may be the same as that mentioned by Smith (1952) where she states that "there are unconfirmed reports of an ancient stone fort close by, which would bear investigation."

References: White, 1855, p. 293.
Smith, 1952, p. 392.

Floyd Co.

(1) Two concentric stone circles enclosing an area of about two acres with walls 2 feet high on a branch of Silver Creek, about 7 miles south of Rome.

(2) A stone enclosure with walls about 3-1/2 feet high, and an area of 1/4 acre, formerly on the west side of Silver Creek 7-1/2 miles south of Rome.

Reference: Thomas, 1891, p. 49.

Habersham Co.

(1) Stone structure, horseshoe shaped, 2 to 4 feet high, at Soquee Post office.

(2) Stone circle formerly on the hill above Glade Creek, on the road from Clarkesville, to Tallulah Falls, 5 miles from Clarkesville.

(3) Stone Wall, nearly obliterated, on the east bank of the Soquee River about 4 miles above Clarkesville.

(Note: none of these could be located by the present writer during 1956, and possibly they have now disappeared.)

Reference: Thomas, 1891, p. 50.

Putnam Co.

The large and well-built stone wall at Devel's Half Acre, south of Eatonton, has already been mentioned in this paper. There are indications of other smaller walls, resembling stone terracing, in the immediate vicinity. Much of the wall has now been destroyed, but one end is in excellent condition and reveals an extremely skillful arrangement of dry stone masonry still standing solidly. This site is one which deserves more attention, especially in view of the importance of stone mounds and effigies in Putnam County. No documentary references are known for this wall, but according to local sources it antedates the white occupation. At any rate, although Putnam County formerly had many plantations this wall does not appear to be connected with agricultural operations.

Rabun Co.

A wall of large, dressed, uncemented stones is reported at Smith's Gold Mine, on the north side of Dick's Creek, 1-1/2 miles west of Burton Post office.

Reference: Thomas, 1891, p. 52.

KENTUCKYCaldwell Co.

A stone wall 600 feet long placed between two ledges occurs near the fork of Dondelson Creek. It resembles a barricade and has a single entrance of gateway. It is composed of large stones and originally stood 6 - 7 feet high. A supply of water is inside.

References: Young, 1910, p. 57. Map.

Webb & Funkhouser, 1932, p. 61.

Carroll Co.

A stone and earth "fortification" on the top of a high hill 2 miles east of Carrollton and 1/2 mile from the Ohio River. Reportedly contains many artifacts, but no details are given.

Reference: Webb and Funkhouser, 1932, p. 72.

Hopkins Co.

A "fortification" enclosing a hilltop and enclosing an area of 11 acres reported 5 miles northwest of Earlington. Formerly the stone walls were breast high, but are now almost obliterated. Four mounds (earth?) containing burials and artifacts were inside.

Reference: Webb & Funkhouser, 1932, p. 189.

Larue Co.

A stone "fort" enclosing 3 to 4 acres, on a bluff on Rolling Fork Creek. Forked or Y-shaped, and apparently in good state of preservation.

Reference: Webb and Funkhouser, 1932, p. 213.

Letcher Co.

Three circular stone walls near the head of Pound River, immediately south of the Virginia border. One, built at a gap in the mountains, resembles a game trap. Many artifacts in the vicinity.

Reference: Webb & Funkhouser, 1932, p. 232.

Madison Co.

A stone and earth "barricade," now almost obliterated, on a ridge 10 miles northwest of Richmond, at a bend in the Kentucky River.

Reference: Webb & Funkhouser, 1932, p. 259.

Mason Co.

A "fortification" of rough stone work is reported on Lee's Creek.

Reference: Webb & Funkhouser, 1932, p. 276.

Nelson Co.

Near Bardstown are several parallel L-shaped stone walls, on the Hogan

KENTUCKY (continued)

farm. They stand 6 feet high and 16 feet wide. The N-S length is 225 feet, and the W-E distance the same. They are of well-laid masonry, and have a stone floor between them with evidence of fires. Now destroyed. Young states that they were definitely known to antedate 1777, when the country was settled.

References: Young, 1910, p. 96.

Webb & Funkhouser, 1932, p. 317.

Trimble Co.

A stone-earth "fortification," called "Indian Fort" on a ridge 1-1/2 miles south of Milton. A trench or ditch accompanies it.

Reference: Webb & Funkhouser, 1932, p. 377.

Warren Co.

Two stone walls, each about 200 feet long, stand at the ends of a "fortification" in the shape of a parallelogram 750 feet on either side. It is located on bluffs 12 miles north of Bowling Green.

References: Young, 1910, p. 57. Map.

Webb & Funkhouser, 1932, p. 385.

Woodford Co.

Stone-earth walls of "considerable size, representing a large amount of labor in its construction" overlook the Kentucky River 6 miles southwest of Versailles.

Reference: Webb & Funkhouser, 1932, p. 414.

TENNESSEE

The Manchester Fort

This structure is well known and is apparently still in good shape, although the present writer has not examined it. It stands at the fork of the Kuck River and the walls are composed of loose stones, apparently from the river bed. The gateway of the enclosure opens towards the neck of land lying between the branches of the river, and is carefully protected by a complicated set of inner works. About half a mile away is a large mound, faced with stone but apparently with an earth core, which has evidently been opened. While no accurate dimensions are available on this stone enclosure, it seems to be of respectable size and all in all has a rather defensive flavor. Quite possibly it is not related to the stone walls and enclosures described in the body of this paper.

The present owner is reportedly unfavourably disposed to archaeologists, professional or otherwise.

References: Jones, 1876, p. 37, Map.
Squier and Davis, 1848, Map.

Lookout Mountain

A short, straight section of stone wall was observed by the writer in 1956 in the town of Lookout Mountain near Chattanooga, almost directly on the Georgia-Tennessee boundary line. It is located on the west side of Lookout Mountain, below the steep bluff and adjacent to or below the old Scholze estate. It runs directly up the slope, which is littered with massive boulders and outcrop. Its present height is about one foot, and its length about 50 feet. It does not appear to be a modern construction, but I was unable to obtain any local information on this point. At any rate, it appears to fit in with the type of wall discussed in the body of this paper.

INDIANAClark Co.

(1) On a ridge at the mouth of Fourteen Mile Creek on the Ohio River are two stone walls. One on the north side is 150 feet long and has a ditch inside. On the south and southwest side is another stone wall 10 feet high, the length of which is not given. Both have ditches inside, and both are of mingled stone and earth in construction.

Reference: Peet, 1891, p. 217. No Map.

(2) A stone "fort" on a long ridge 3 miles southeast of Charleston. Earth and stone walls, often faced with stone slabs, 6 to 8 feet high.

Reference: Lilly, 1937, p. 50. No Map.

Jefferson Co.

Stone walls, described as "defensive" are reported 25 miles north of Fourteen Mile Creek, about 1-1/2 miles south of Paris Crossing.

No other information is given. No Map.

Reference: Lilly, 1937, p. 52.

OHIOButler Co.

A stone and earth wall, averaging 5 feet in height and 35 feet thick at the base, was located 3 miles below Hamilton on the west side of the Great Miami River. It enclosed a hilltop and had 4 complex entrances. Four stone mounds, which had been opened, were inside the enclosure. The total length is not given.

Reference: Squier and Davis, 1848, p. 16. Map.

Highland Co.

Fort Hill, 30 miles from Chillicothe. An enclosure occupying the summit of a hill, enclosing 48 acres. It is made of a series of short walls of earth and stone with 33 gateways. Total length 8224 feet; height from 6 to 15 feet.

Reference: Squier and Davis, 1848, p. 14. Map.

Jefferson Co.

Two stone walls extend across the narrow neck of a ridge near Big Creek. One is 175 feet long, the other 425 feet. They enclose an area of 12 acres. Three stone mounds are nearby.

Reference: Peet, 1891, p. 218. No Map.

Miami Co.

Earth and stone wall forming an enclosure of 18 acres, oval in shape, on the left bank of the Great Miami River, 2-1/2 miles above the town on Piqua on Col. Johnson's farm. It occupies a hill terrace and has four gateways.

Reference: Squier and Davis, 1848, p. 23. Map.

Preble Co.

A straight stone wall or line of stones 700 feet long and 12 feet wide, at the junction of Twin Creek, 6 miles southeast of Eaton on the Great Miami River. An earth embankment appears to extend behind it.

Reference: Squier and Davis, 1848, p. 33. Map.

Ross Co.

Near Bournesville a low stone wall encloses a hilltop about 140 acres in area. The length of the wall is given as 2-1/4 miles.

Reference: Squier and Davis, 1848, p. 11. Map.

V. BIBLIOGRAPHY

BURROUGHS, W. G.

- 1926 Geography of Kentucky Knobs. Kentucky Geological Survey Series VI, Vol. XIX.

DRAGOO, DON W.

- 1955 The Linn Mound, An Upper Ohio Valley Adena Stone Mound. Pennsylvania Archaeologist, Vol. XXV, No. 1.

FAIRBANKS, C. H.

- 1949 A General Survey of Southeastern Prehistory. In The Florida Indian and His Neighbors (John W. Griffin, editor). Winter Park, Florida.

- 1952 Creek and Pre-Creek. In Archaeology of the Eastern United States, James B. Griffin, editor. Chicago.

INGHRAM, JOSEPH

- n.d. The Fayette County "Wall" Site (46-Fa-1). (Unpublished paper presented to the West Virginia Archaeological Society).

JENNINGS, J.

- 1946 Hopewell-Copena Sites Near Nashville. American Antiquity, Vol. 12, p. 126.

JONES, CHARLES C., JR.

- 1873 Antiquities of the Southern Indians. N.Y.
1877 Aboriginal Structures in Georgia. Annual Report of the Smithsonian Institution. Washington.

JONES, JOSEPH

- 1876 Exploration of the Aboriginal Remains of Tennessee. Smithsonian Contributions to Knowledge 259, Volume 22.

KELLY, A. R.

- 1938 A Preliminary Report on Archaeological Explorations at Macon, Ga. Bureau of American Ethnology, Bull. 119, Anthropological papers, No. 1.
1954 The Eatonton Effigy Eagle Mounds and Related Stone Structures in Putnam County, Georgia. Georgia Mineral Newsletter, Vol. VII, no. 2.

KELLY, A. R. & E. BEAM

- n.d. Exploration of a Stone Mound in Lumpkin County, Georgia. (Unpublished report in files of the Department of Anthropology, University of Georgia, Athens).

KNIGHT, L.L.

- 1914 Georgia's Landmarks, Memorials and Legends, Vol. II. Atlanta.

LANMAN, CHARLES

- 1849 Letters from the Alleghany Mountains. Putnam. New York.

- LILLY, ELI
1937 Prehistoric Antiquities of Indiana. Indiana Historical Society. Indianapolis.
- MULLOY, WILLIAM
1952 The Northern Plains, in Archaeology of the Eastern United States (James B. Griffin, editor). Chicago.
- NORMAN, B. M.
1849 Rambles in Yucatan. Philadelphia.
- PEET, S. D.
1891 Defensive Works of the Moundbuilders. American Antiquarian & Oriental Journal, Vol. XIII, no. 4.
- PETRULLO, VINCENZO
n.d. Rock Eagle Effigy Mounds and Related Structures in Putnam County, Georgia. (Unpublished report in files of the Department of Anthropology, University of Georgia, Athens).
- ROBERTS, RALPH G.
1949 Ancient Stone Fortification at De Soto Falls, Little River, Alabama. Tennessee Archaeologist, Vol. V, No. 2, May, 1949.
- SHACKELTON, ROBERT, JR.
1893 Fort Mountain. The American Antiquarian & Oriental Journal, Vol. XV, pp. 295-304.
- SMITH, MARGARET P.
1952 Unusual Georgia Petroglyph. American Antiquity, Vol. XVIII, No. 4, p. 392.
- SMITH, PHILIP E.
n.d. Archaeological Reconnaissance in Fort Mountain State Park. (Unpublished report submitted to the Georgia Department of State Parks, Atlanta.)
- SQUIER, E. G. AND E. H. DAVIS
1848 Ancient Monuments of the Mississippi Valley. Smithsonian Institution. Washington.
- THOMAS, CYRUS
1891 Catalogue of Prehistoric Works East of the Rocky Mountains. Smithsonian Institution, Bureau of American Ethnology, Bull. 12.
- WALKER, R. S.
1941 Lookout, the Story of a Mountain. Kingsport, Tennessee.
- WARING, A. J., JR.
1945 Hopewellian Elements in Northern Georgia. American Antiquity, Vol. XI, No. 2.

WEBB, W. S. and W. D. FUNKHOUSER

- 1932 Archaeological Survey of Kentucky. University of Kentucky Reports in Archaeology and Anthropology, Vol. II.

WHITE, GEORGE

- 1849 Statistics of the State of Georgia. Atlanta.
1855 Historical Collections of Georgia. New York.

WHITTLESEY, CHARLES

- 1861 The Great Mound on the Etowah River, Georgia. Annual Report of the Smithsonian Institution for 1881, pp. 624-30.

YOUNG, BENNETT

- 1910 Prehistoric Men of Kentucky. The Filson Club, Publication No. 25, Louisville, Kentucky.